

PENTAX®



67

OPERATING MANUAL

Welcome to the world of Pentax Medium Format Photography. The 67's picture format gives an image area four times larger than that of the 35mm SLR camera, assuring the photographer of finegrained, superior quality image definition on enlargements.

Careful reading of this operating manual will help you take advantages of all the photographic capacities this equipment has to offer. Please be on the look out for the special directions with a "●" mark in the colored column.



The names of the camera's working parts are listed in the nomenclature section inside the front and back flaps. Please keep the flaps unfolded for quick reference while you read this manual.



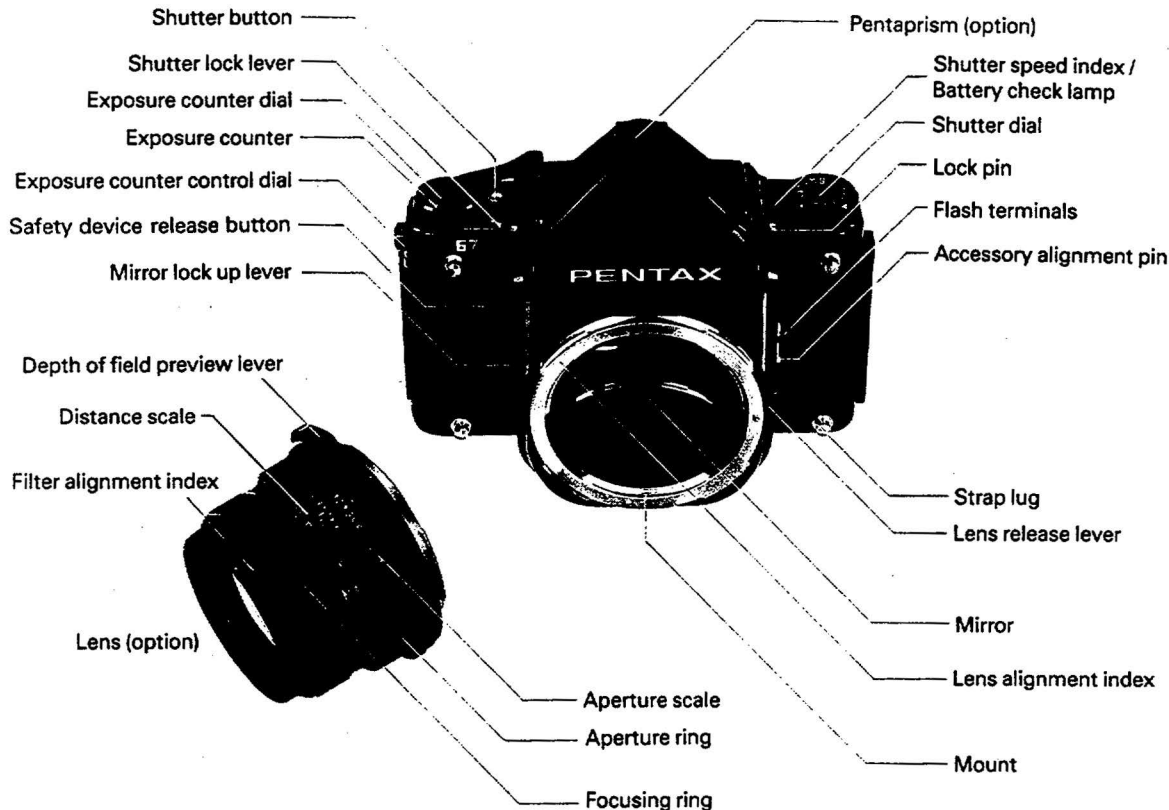

Notes to Users

Commercially available lenses and accessories produced by other manufacturers are not made to our precise specifications and therefore, may cause difficulties with — or actual damage to — your Pentax camera. We do not assume any responsibility or liability for difficulties resulting from the use of lenses and accessories made by other manufacturers with Pentax cameras and photographic products.

Photographs and/or illustrations of the products in this operating manual may differ from the actual product in its details.

- As the shutter is electronically controlled, the camera will not operate without a battery. Please use one of the following battery types; (Refer to Page 3)
 - 6V ALKALINE Battery (4LR44, A544)
 - 6V SILVER-OXIDE Battery (4SR44, 544, PX28)
- New battery is packed at the time of shipment, but because of inherent self-discharging, performance gradually deteriorates and the battery may be in marginal or dead condition by the time you purchase the product. In such a case, replace the packed battery with a new one.
- Whenever loading film, make sure to set the pressure plate and exposure counter control dial according to the film type you are using. (Refer to Page 13~14)
- Load the film correctly according to the procedure mentioned hereafter. (Refer to Page 15~19)

TABLE OF CONTENTS

Nomenclature Flaps

PREPARATIONS

Attaching shoulder strap2

Inserting battery3 ~ 5

Interchangeable finders6 ~ 7

Mounting lens8 ~ 9

Shutter release without film10 ~ 11

LOADING FILM

Setting film type (120/220)13 ~ 14

Loading film15 ~ 19

Unloading film20

BASIC OPERATION

Shutter dial/button22 ~ 23

Setting aperture24

Holding camera25

Diopter adjustment and focusing26 ~ 27

Exposure28

APPLICATIONS

B(Bulb) and Time photography30

Mirror-lock-up lever31

Flash photography32 ~ 33

Depth of field34

Infrared index35

ACCESSORIES36 ~ 41

OPERATIONAL PRECAUTIONS42

MAINTENANCE43

TROUBLE-SHOOTING44 ~ 45

INTERCHANGEABLE LENSES46 ~ 47

WARRANTY POLICY48 ~ 49

SPECIFICATIONS51

PREPARATION

The shoulder strap can be attached to any pair of the four strap lugs on the 67 camera body.

ATTACHING SHOULDER STRAP

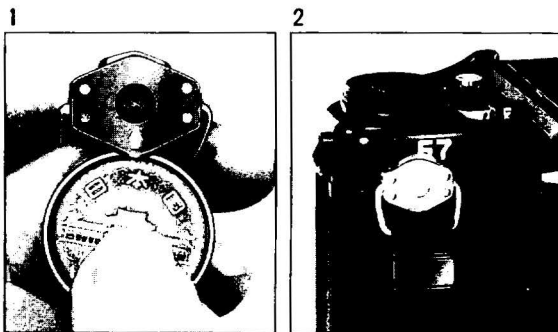

1. Open the clasp by inserting a coin or the Shutter cocking key in the direction of the arrow.
2. Put the clasp onto the strap lug and press the lock.
3. Adjust the length of the strap by changing the position of the strap clasp.

- After fitting the strap and adjusting the length, pull the strap hard to see if the strap has securely attached to the camera.

INSERTING BATTERY

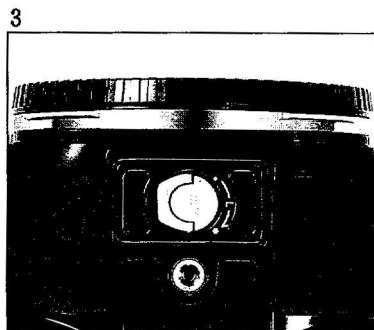
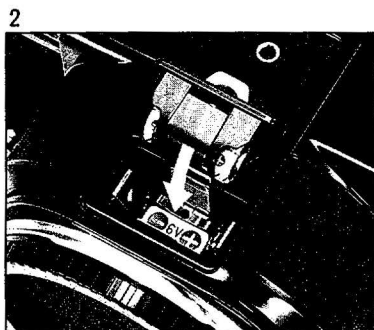
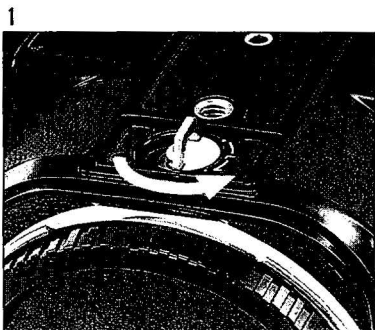

Use one of the battery types mentioned below;
6V Alkaline battery (4LR44, A544)
6V Silver-oxide battery (4SR44, 544, PX28)

- If the shutter is operated without a battery or the battery is installed incorrectly, the safety device will be activated and the mirror will stop partway up.
- Insert a new battery when the mirror is in the normal position, not when it is partway up, as it will shorten the battery life.

1. Lift up the crank on the bottom of the camera and turn it counterclockwise, and take out the battery case.
2. Put a new battery into the battery case and reinsert the battery case making sure that the (+) and (-) marks on the battery correspond with the (+) and (-) marks inside the battery chamber.
3. To secure the battery case, turn the crank in the direction of the arrow until the red dots align.

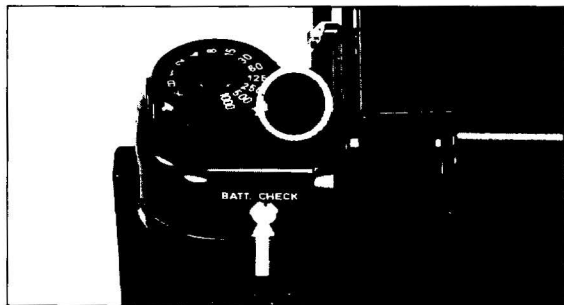

Press the battery check button at the back of the camera. If the battery check lamp does not light, the battery power is insufficient. In such a case, replace the battery immediately.

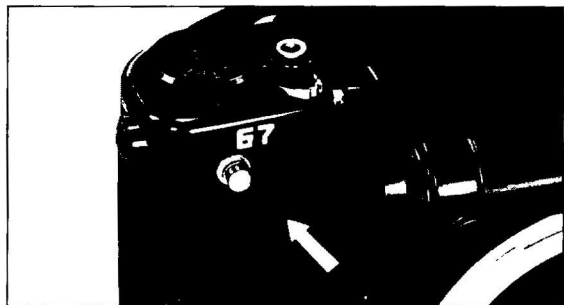

Press the safety device release button with a pointed object, and press the shutter button for one blank exposure. The mirror will then return to its original down position.

- When the battery power becomes insufficient, the mirror will stop partway up blocking the viewfinder.
- It will shorten the battery life if the battery check button is pressed too frequently.
- The shutter may work for a while even if the battery lamp does not light. However, the shutter speeds may be inaccurate.

- Use the Alkaline battery (4LR44, A544) or the Silver-Oxide battery (4SR44, 544, PX28) aligning the polarities correctly.
- Always keep batteries out of the reach of children.
- The misuse of batteries may cause hazards such as leakage, over heating, explosions, etc.
- To prevent explosion:
 - never try to break a part,
 - never recharge the battery,
 - never throw into fire,
 - never expose to excessive heat.
- The Alkaline battery should last about 6 months, while the Silver-Oxide battery about one year with average use at normal temperature. However, when the TTL pentaprism is used, the battery will last less as it also activates the TTL meter.
- At temperature below 0°C (32°F), battery performance may temporarily decrease. One way to avoid this is to use the 67 remote battery cord (optional) for keeping the battery warm under your clothing.
- Keep a spare battery on hand for convenience when shooting outdoors or traveling.
- Make sure to remove the battery when the camera is not in use for an extended period of time, as the battery may deteriorate and cause damage to the contact points.



INTERCHANGEABLE FINDERS

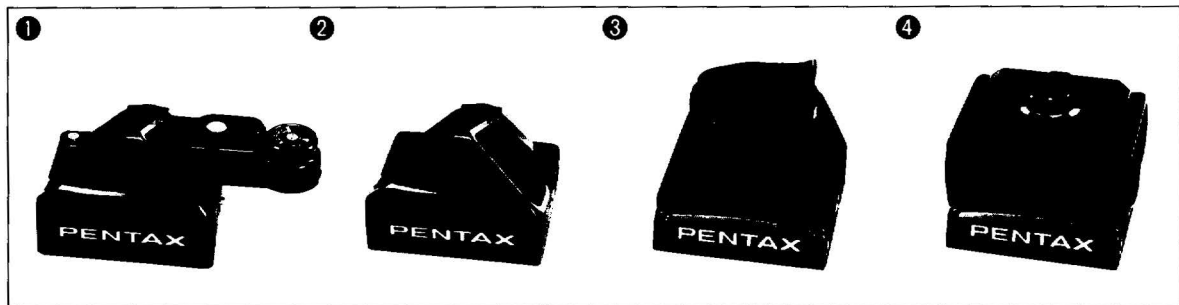

There are four types of interchangeable finders (Optional) for the 67 camera as mentioned below;

Eyelevel viewfinder:

- ① TTL Pentaprism
- ② Pentaprism

Waist-level viewfinder:

- ③ Rigid Magnifying Hood
- ④ Folding Focusing Hood

Grasp the finder on the top from both sides and fit it into the finder mount until it locks in place with a click heard from both side of the finder mount.

Once attached, jiggle it back and forth to confirm that it is securely locked.

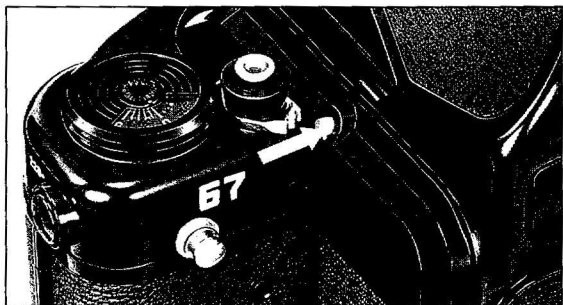

Press the lock pins on both sides of the finder and lift it straight up.

- In a bright environment, film may be accidentally exposed if the finder is detached while the shutter is open for an extended period.
- To prevent an accidental exposure, protect the finder eyepiece from strong light such as direct sun light.



With the TTL pentaprism or Pentaprism, approximately 90% of the total area is visible. With the Rigid Magnifying hood or Folding focusing hood, 100% of the image area is visible, but the image is laterally reversed.

MOUNTING LENS



The 67 camera's lens mount has two types of bayonet, inner bayonet and outer bayonet. Except SMCP 67 Shift 75mm f/4.5 and SMCP 67 Soft 120mm f/3.5, the inner bayonet lenses are equipped with automatic diaphragm.

1

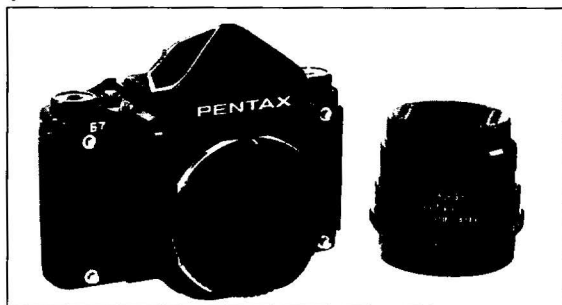

1. Detach the mount caps on both the camera and lens by turning counterclockwise.

- For the outer bayonet lenses, please refer to the operating manual, 67 INTERCHANGEABLE LENSES.

2

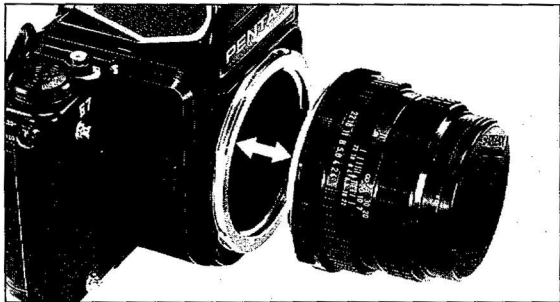

2. Align the red indexes on the camera and lens, and turn the lens clockwise. The lens will be locked in place with a click.

- When an automatic diaphragm lens has been attached on the camera before mounting the TTL pentaprism, remove the lens and remount it. This is for setting the coupling pin of the TTL pentaprism with the camera's diaphragm coupling slide.

3

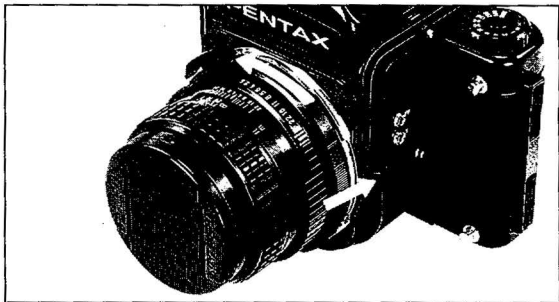

3. To detach the lens, turn the lens counterclockwise while pressing the lens release lever.

- When the lens is dismounted, attach the caps onto the lens and camera to prevent dirt from getting in the mechanism.

SHUTTER RELEASE WITHOUT FILM



The shutter mechanism of the 67 camera is designed to be disengaged when a film is not loaded. Should you need to release the shutter without loading film, follow either one of the following methods.

1. Open the camera back by sliding the release tab.
2. Turn the exposure counter dial counter-clockwise until the counter indicates "1" or more.

3

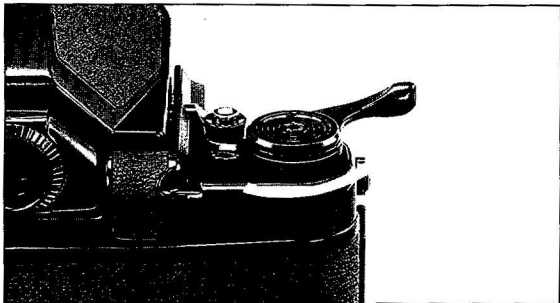

3. Close the camera back while keeping your finger on the exposure counter dial. Turn the wind lever until the shutter is cocked.

1



2

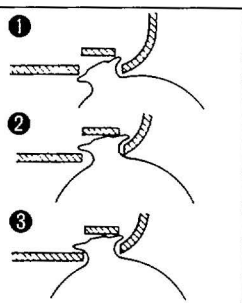

1. Cock the shutter as described in the procedure A].
2. Open the camera back and insert the shutter cocking key into the slot below the wind lever as illustrated. Then, the shutter can be released without closing the camera back.

- To prevent damage to the inside mechanism, never touch the shutter curtain or counter roller.

LOADING FILM

(Please go through "BASIC OPERATION" before actually loading a film.)

SETTING FILM TYPE

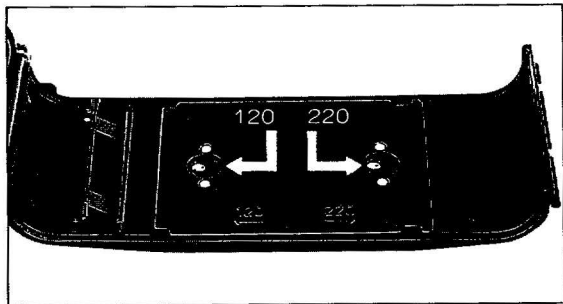

The 67 camera accommodates two types of film: 120 type (10 exposures) and 220 type (20 exposures).

Whenever changing film types, the following two adjustments must be made.

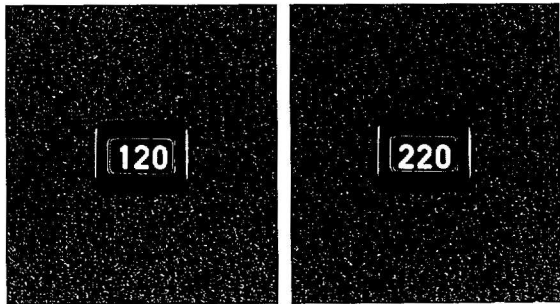

The plate position can be confirmed through the 120/220 film indicator on the camera back. As shown in the photo, press and shift the pressure plate according to the film type you are using.

- The thickness of the film differs between the 120 type and 220 type (120 type: With back paper, 220 type: Without back paper). Film drag and imprecise focusing will occur, if the pressure plate is not set correctly.



120 type

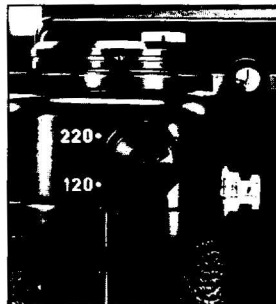

220 type

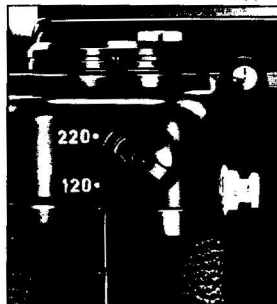

With a coin or the shutter cocking key, set the exposure counter control dial to correspond with the type of film you are using. The number of exposure will be set by this dial (120 type: 10 exposures, 220 type: 20 exposures).

- When the 120 type 6-exposure film is used (5 exposures can be made by the 67), please make 5 blank exposures after the 5th frame.

- Even if you have set the dial to the wrong position, you can correct the position as long as you have not gone past the 9th frame. Make sure not to correct the dial position after the 9th frame as doing so causes damage to the camera.

LOADING FILM (Avoid direct sunlight when loading or unloading film.)

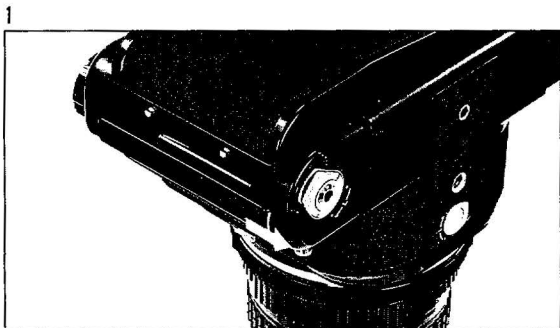

To avoid film jams, load the film correctly according to the procedure mentioned hereafter.

1. Open the back cover by sliding the release tab.

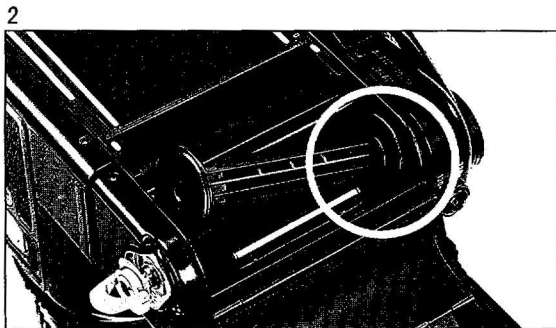

2. Unfold the crank of the film spool retainer knob, turn the knob counterclockwise and pull down. Engaging the hole of the spool to the upper film retainer, put an empty spool into the film chamber below the wind lever. Then, push in the retainer knob and turn it clockwise to lock in place.

3

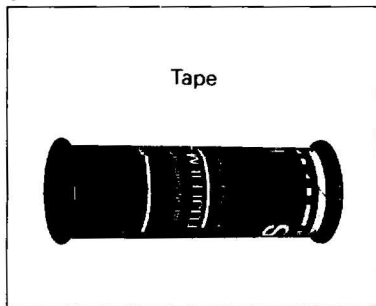

4

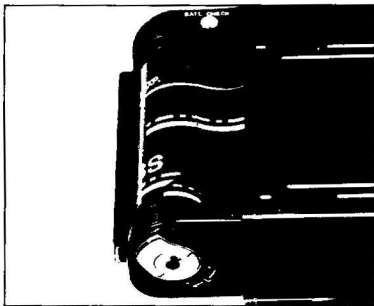

5

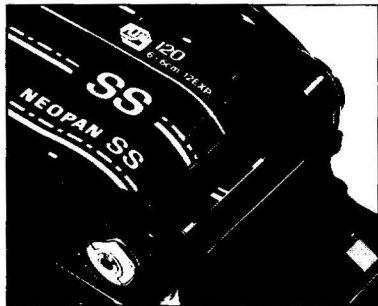

3. Remove the tape completely from a new film to be put in the camera.
4. Place the new film in the film chamber below the shutter dial in the same manner as the empty spool.

5. Turn the wind lever until the slot of the empty spool faces upward. Then, pull out the film's leader and thread it into the slot.

- To prevent damage, never touch the shutter curtain.

- To avoid film jam, roll the film leader firmly and evenly.

6

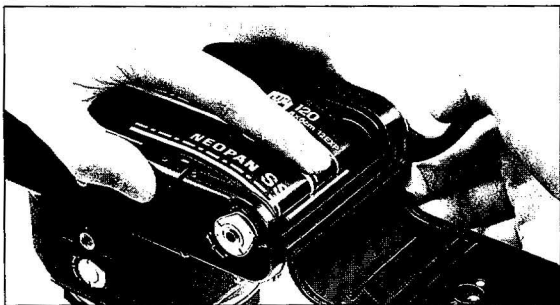

6. Turn the wind lever until the spool has made one revolution, while pressing the film leader as shown in the photo.

- Never turn the spool in the opposite direction. It may damage the wind mechanism.

7



7. Make sure the leader is evenly rolled onto the spool. If not, repeat the procedure 5 and 6 until the film leader is set correctly.

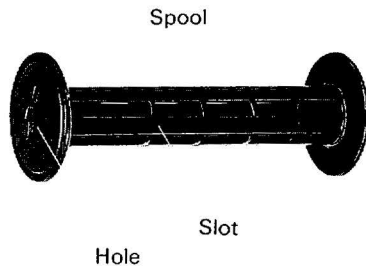

8

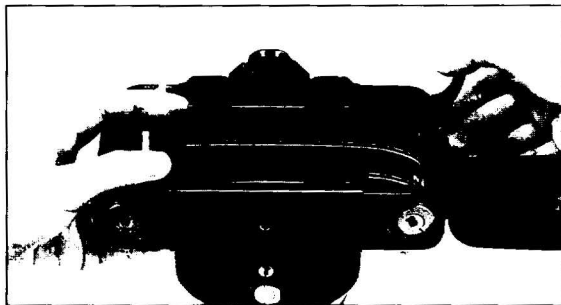

8. Press on the film as shown in the photo while turning the wind lever so that the leader is wound tightly onto the spool. Be sure not to press the shutter curtain.

9

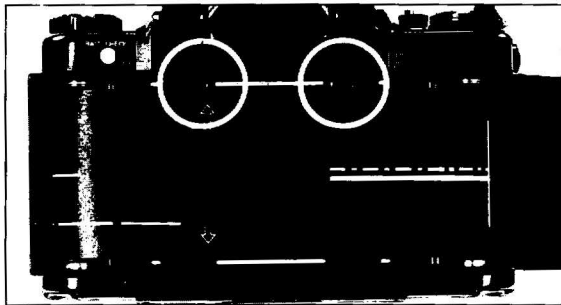

9. Keep turning the lever until the arrow mark (Film mark) aligns with the index of the film type you are using.

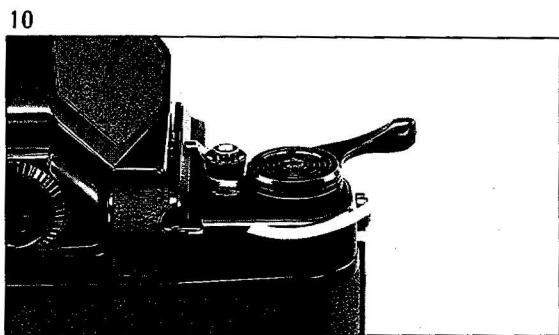
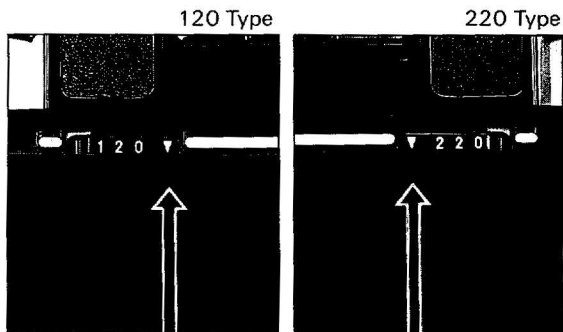

10. Close the camera back. Keep turning the wind lever until the counter indicates "1". The shutter is cocked and the camera is now ready for the first exposure.

- Make sure to set the film mark correctly. Otherwise, the first frame or last frame may be cut off.
- In some films, a dotted line appears before the film mark. Make sure not to be misled by this marking.

UNLOADING FILM



After you have exposed the proper number of frames of the type of film you are using, the shutter will be disengaged to allow turning of the wind lever continuously. Keep turning the lever until there is little resistance, and open the camera back. After pulling out the film retainer knob, press down on the rim at the top of the spool. Take out the film and seal the roll.

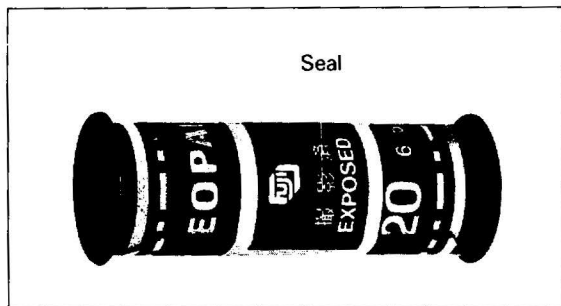

- Handle the exposed film carefully. Should the roll of film loosen, accidental exposure to light may happen damaging your photographs. Also, do not tighten the roll too much as this may cause a damage to the film.
- Do not force the wind lever when it becomes taut. It may damage the shutter and/or wind mechanism.

BASIC OPERATION

SHUTTER DIAL/BUTTON

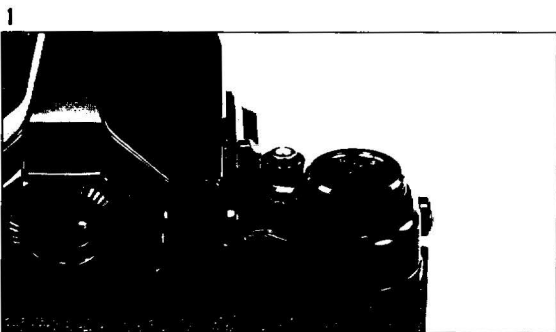

To prevent camera shake, please press the shutter button gently, while holding the camera securely. Please practice releasing the shutter to capture the moment as you desire without causing camera shake.

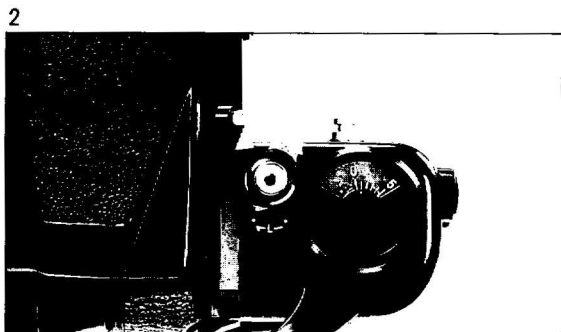

When the shutter lock lever is aligned to the red dot, the shutter is locked. This is helpful to prevent accidental shooting.

3

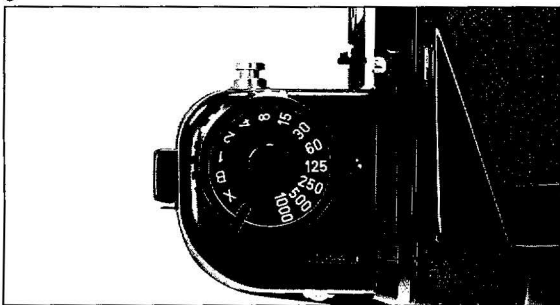

To set the desired shutter speed, rotate the shutter dial in either direction until the shutter speed indicated on the dial matches the shutter speed index (Battery check lamp). Speeds from 1 to 1/1000, X and B can be set.

- If you set the dial anywhere between the dial's indicated settings, such as "1000" and "X", the shutter will remain open until one of the indicated speeds is set.
- If the camera is left for an extended period of time after cocking the shutter, the shutter speeds will become inaccurate.

SETTING THE APERTURE



F-Number

The aperture can be set by rotating the aperture ring until the desired F-number is aligned with the index [◇]. An intermediate F-number can be set as well. The values of F-number and intermediate F-number are basically as follows;

2, 2.8, 4, 5.6, 8, 11, 16, 22, 32, 45
2.4, 3.4, 4.8, 6.7, 9.5, 13.5, 19, 26, 38



Almost all the SMC PENTAX/TAKUMAR 67 lenses with inner bayonet are equipped with the automatic diaphragm. The diaphragm stays fully open until the moment the shutter is released.

- For lens details, please refer to the operating manual, 67 INTER-CHANGEABLE LENSES.

HOLDING CAMERA



When shooting, hold the camera securely with both hands. Keep the camera as still as possible, and gently press the shutter button. (If pressed forcefully, the camera is likely to shake, and the picture will be blurred.)

Try to brace your elbow against your body, or support yourself and the camera against a stable stationary object such as a wall.

- When utilizing a slower shutter speed or a telephoto lens, mount the camera onto a sturdy tripod and use a cable release to prevent camera shake.

DIOPTR ADJUSTMENT AND FOCUSING

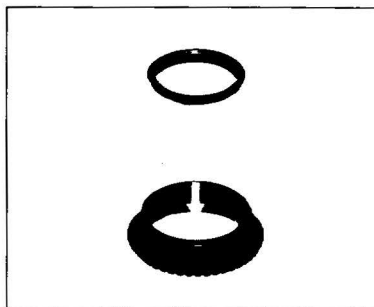
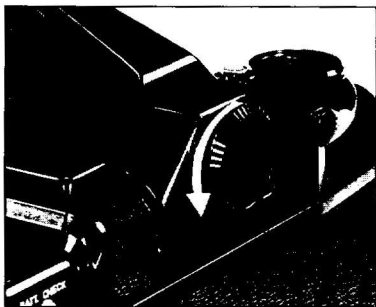

For accurate focusing, please check if the focusing screen can be seen clearly. Should you need a diopter adjustment, please use a correction lens (option).

Turn the eyepiece frame counterclockwise and remove it. Turn the inside ring and replace the plain glass with a correction lens.

- The diopter of the TTL Pentaprism and Pentaprism is $-1D$. If you are not able to read the letters of a news paper 1 m away, you would better put a correction lens in the viewfinder eyepiece. $-1D$ should normally be sufficient for near sighted people, while the $+1D$ should be sufficient for farsighted people.

In focus



Out of focus



Turn the focusing ring of the lens until the image seen through the central microprism pattern appears sharp. The matte area surrounding the circular microprism can also be used when focusing on objects not in the center or when the lens has a maximum aperture smaller than $f/5.6$. To focus on the matte area, simply turn the focusing ring until the image appears to be in focus.

- As for Interchangeable Focusing Screen, please refer to page 36.

EXPOSURE

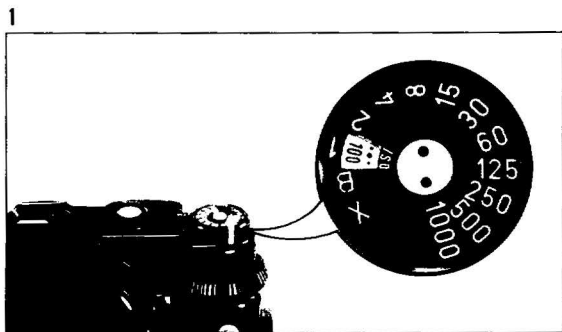

Since the 67 camera has no exposure meter, a hand held exposure meter or the TTL Pentaprism should be used to measure the light. The way to use the TTL Pentaprism is as follows;

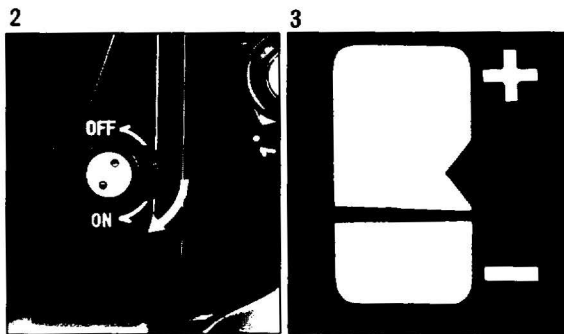

1. Set the ISO rating of the film loaded by lifting and rotating the finder's outer ring of the shutter dial.
2. Turn the switch to the ON position.
3. Adjust the lens aperture ring or shutter dial until the needle in the meter window matches the center index. The TTL Pentaprism metering system is an overall averaging metering type.

- For the details of the TTL Pentaprism, please refer to the operating manual, 67 TTL PENTAPRISM FINDER.

APPLICATIONS

B (BULB) AND TIME PHOTOGRAPHY

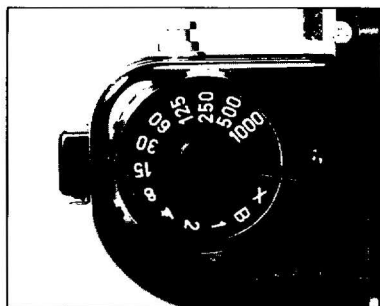
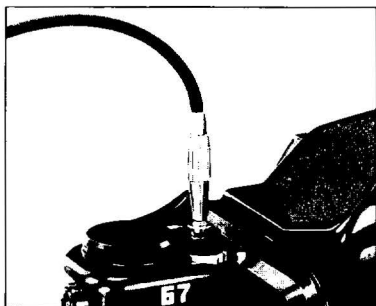
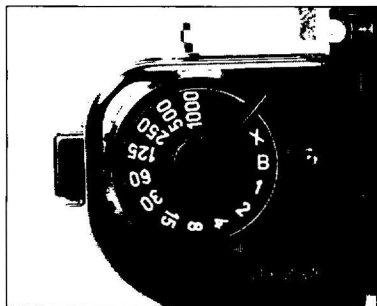

At the B setting on the shutter dial, the shutter remains open as long as the shutter release button is held down. This is especially useful for shooting such subjects as fireworks and night scenes. Mount the camera on a sturdy tripod and use a cable release to prevent camera shake.

Although there is no setting for long time exposure, time exposure is possible when the shutter dial is set anywhere between the clicks.

The shutter remains open until the shutter dial is set to one of the indicated setting.

- The battery is being exhausted as long as the shutter is open. A new 4SR44 Silver-Oxide battery lasts about 5 hours when the shutter is kept open constantly under our testing conditions.

MIRROR LOCK UP LEVER

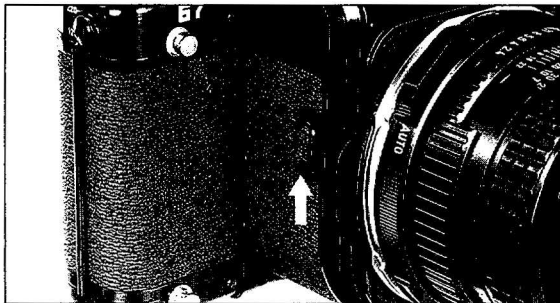

At shutter speeds slower than 1/60 sec., blurring may occur even when a tripod is used. Blurring is also likely to occur when using the Auto Bellows, Extension tube or large lenses over 300mm.

- The lens shutter of the 165 f/4.0 LS cannot be used when the mirror lock up lever is operated.

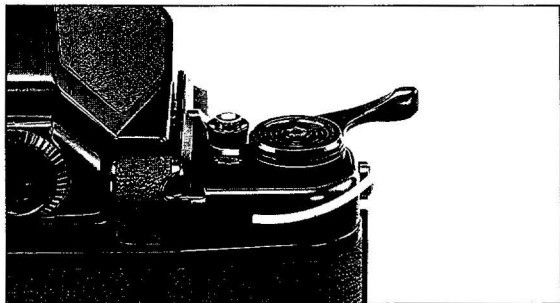

After composing and focusing, slide the mirror lock up lever to lock the mirror in its upward position. The mirror will return automatically after you release the shutter.

- The battery is being exhausted as long as the mirror is held up. A new 4SR44 Silver-Oxide battery lasts about 5 hours when the mirror is kept constantly held up under our testing conditions.

FLASH PHOTOGRAPHY

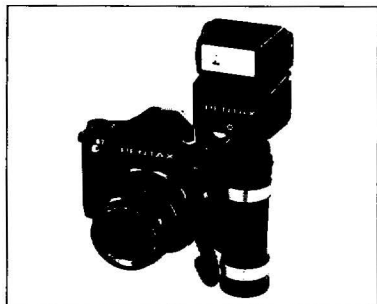
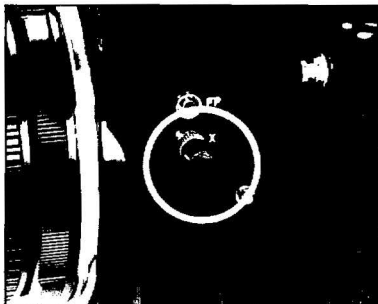
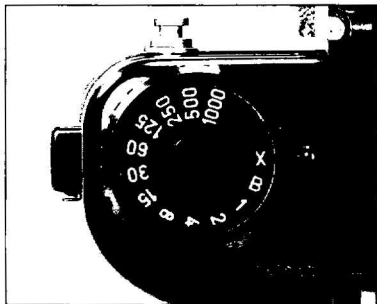

To connect an electronic flash to the 67 camera, a synchro cord with the JIS (PC) type plug should be inserted to the X terminal. Set the shutter dial at X (1/30sec) or any speed slower than 1/60 sec.

To attach the Pentax AF400T flash unit, set up the 67 body with the AF400T 67 bracket and connect them using the 4P synchro cord C. Other clip-on type electronic flash unit can be attached to the 67 by either of the following ways;

- Hot shoe grip + AF400T 67 bracket + 4P synchro cord C
- 67 grip + 645 hot shoe adapter LS

- Both shutter speed and lens aperture must be set manually when using any electronic flashes.

Shutter speed		1/1000	1/500	1/250	1/125	1/60	1/30	1/15	1/8	1/4	1/2	1	X
Terminal	X							Electronic flash					
								M class, MF class					
	FP				FP class								

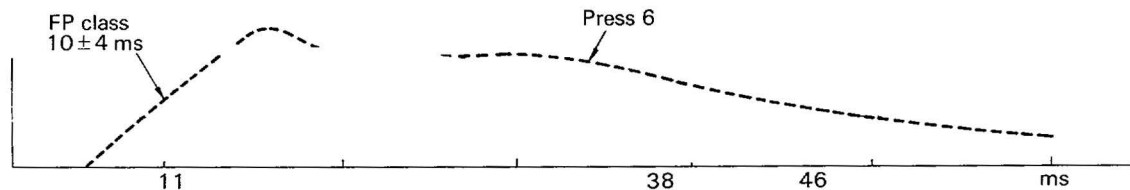

M class and MF class flashbulb can be used at shutter speeds 1/15 sec. or slower. FP class can be used at 1/8 sec. or slower.

The FP class flash units presently on the market do not synchronize with the 67. However the Press 6 flash bulb can be used at the shutter speeds of 1/250 sec. and 1/125 sec. if the black and white film is used.

DEPTH OF FIELD

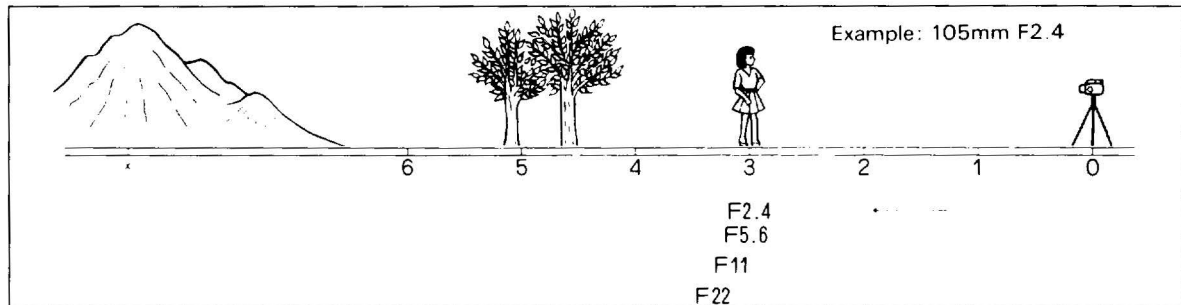

Depth of field refers the range around the optimum focusing point of the subject in which the elements at different distances are in focus. The in-focus range can be confirmed by the depth of field scale on the lens. When using an automatic diaphragm lens, in-focus zone can be actually seen by setting the depth of field preview lever to manual (MAN.).

1. With the same focal length of lens and the same camera to subject distance, the depth of field increases as the aperture becomes smaller.
2. With the same focal length of lens and the same F-stop, the depth of field increases as the camera to subject distance becomes greater.
3. With the same camera to subject distance and the same F-stop, the depth of field increases as the focal length becomes shorter.

INFRARED INDEX

(1)

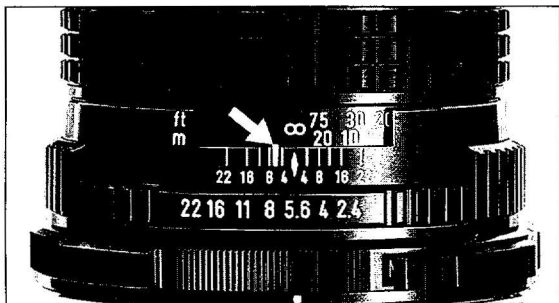

When taking infrared photographs using infrared film and either the R2 or O2 filter, it will be necessary to compensate for the difference between the visible light and infrared light focus.

(2)

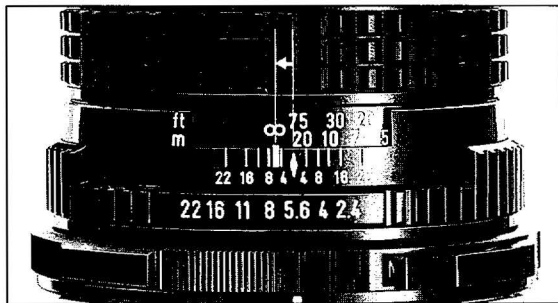

As referenced in the photos above, (1) read the camera to subject distance on the focusing ring after focusing through the viewfinder. Then (2) turn the focusing ring until the distance setting aligns with the red infrared index. The picture shows an example where the camera to subject is infinity (∞).

- For exposure control, refer to the film's instructions.

ACCESSORIES

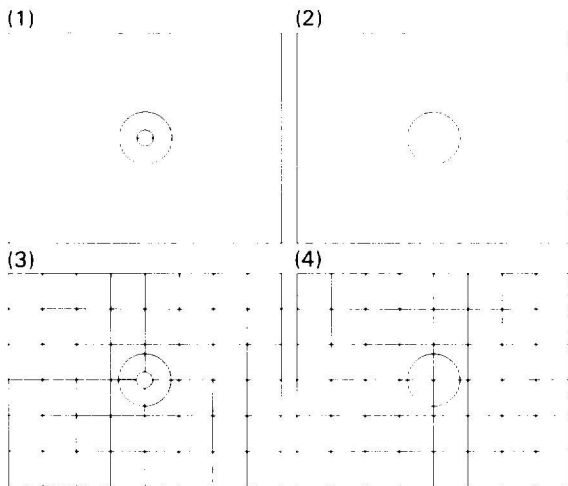

Besides the standard microprism screen, there are four types of focusing screens as follows;

- (1) Split Image,
- (2) Matte with Central Open Spot,
- (3) Grid with Microprism,
- (4) Grid with Matte

The replacement should be performed at the nearest Pentax service facility.

Focusing with split image:

The image is in focus when the images above and below the split line up.

Focusing screens with grid:

The grid is useful to check the horizontal or vertical lines in an image are parallel. The horizontal and vertical lines are spaced at 9mm.

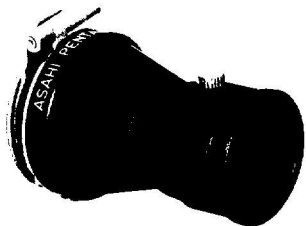

For precise focusing, this compact magnifier provides two times enlargement of the central area. Includes a built-in diopter adjuster.

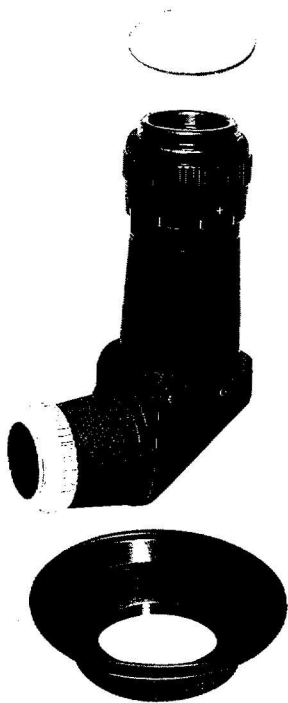

To adjust the diopter of the TTL Pentaprism or Pentaprism. 7 types (from $-5D$ to $+2D$) of correction lenses are available. Please refer to Page 26.

Attached to the eyepiece of either the TTL Pentaprism or Pentaprism, the finder can be used vertically and horizontally. Includes a built-in diopter adjuster.

Put the eyepiece ring of either the TTL Pentaprism or Pentaprism into the groove of the Eyecup, then screw it into the eyepiece frame. It blocks distracting light and improves the visibility. Not recommended for eyeglass wearers.

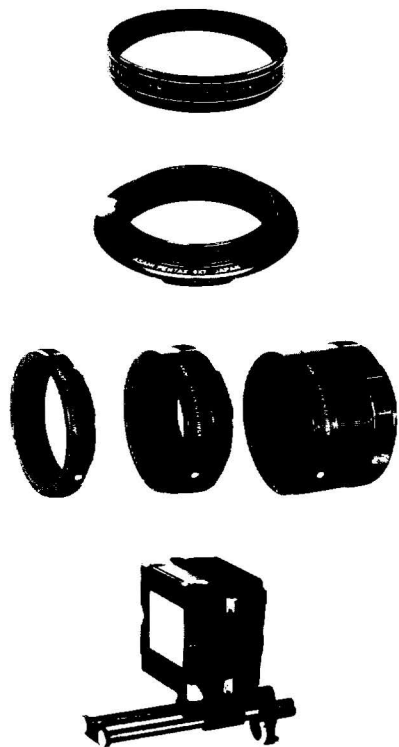

67 SMC Close-up Lenses
67 Auto Extension Tube
67 Hellicoid Extension Tube
67 Auto Bellows
67 Slide Copier
67 Reverse Adapter
Large Copying Stand II

From easy close-up photography with the Close-up lenses to macro photography with the versatile Auto Bellows, there are a wide range of accessories. There are also accessories for duplicating slide or copying pictures.

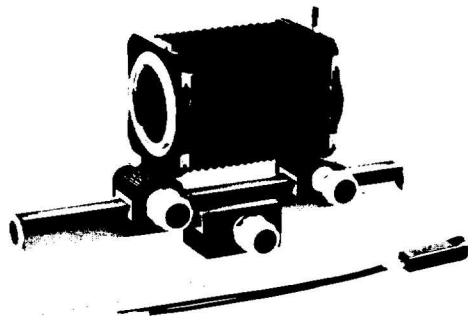

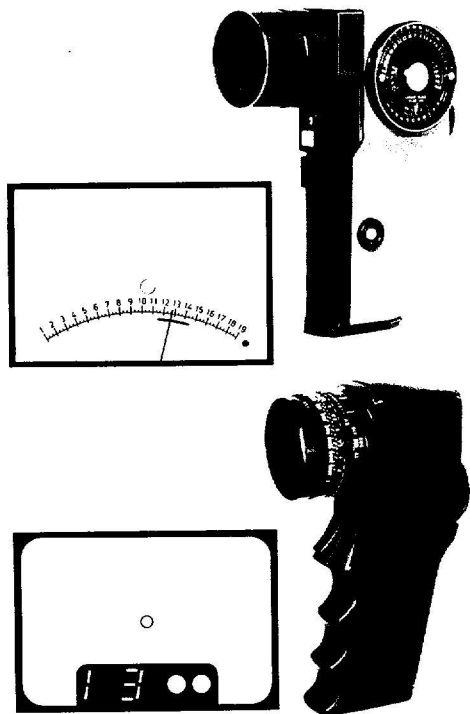

Spotmeter V

Digital Spotmeter

Designed for use by professionals in still photography as well as those in the motion picture and television industries. The angle of light reaching the meter is only 1°.

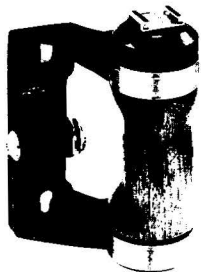

The grip provides rigid support of the 67 camera. With the accessory shoe, a clip-on type electronic flash unit can be mounted. Please refer to page 32.

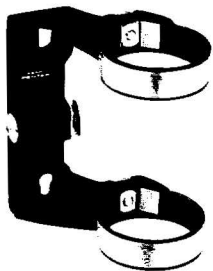

This bracket enables you to attach the AF400T electronic flash unit to the 67. It attaches to the camera in the same manner as the 67 grip.

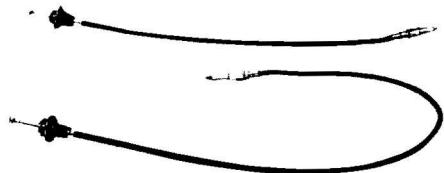

30cm and 50cm type are available. An auto-lock ring is provided for time exposures.



Permits you to operate the camera in cold weather while keeping the battery in a warm pocket.

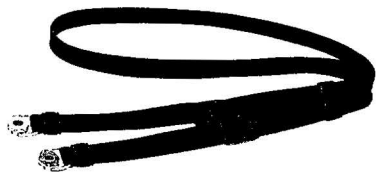

Additional support for the camera will be obtained by attaching a second strap.



67 Carrying Case
67 Professional Trunk Case II

OPERATIONAL PRECAUTIONS

- Dropping or banging the camera against stationary objects can damage the camera in many ways.
- Dirt, mud, sand, water, noxious gas and salty sea breeze / spray can cause serious damage to the mechanisms inside the camera. Remove them from the camera surface with lens-cleaning fluid, lens cleaning tissues, etc. and have it checked by a Pentax service facility or an authorized repair shop immediately.
- Your camera is not water-proof. It must be protected from salty sea breeze / spray at the beach, splashing liquid of anykind, and rain.
If your camera gets wet, wipe it dry immediately and have it examined at a Pentax service facility.
- The temperatures at which this camera should function properly are approx. 50° ~ -10°C (122°-14°F).
- Never attempt to touch the mirror, focusing screen, shutter curtain, etc.
- Humidity and temperature extremes should be avoided. Keep out of direct sunlight, car trunks, glove compartment, etc.
- Sudden changes in temperature often cause condensation of moisture inside or on the outside your camera. This might cause extremely damaging rusting of the mechanism. Keep the camera in its case or a bag to minimize the effect of a sudden temperature change.
- When mounting your camera on a tripod, make sure the tripod screw is no longer than 5.5mm (0.22 in.) which is the depth of your camera's tripod socket, or the camera may be damaged.
- Vibration from traveling in a car, aircraft or ship can cause screws to loosen. To minimize this problem, line the bottom of your camera bag with inch-thick (2.54cm) foam rubber padding.

MAINTENANCE

- Make sure to remove the battery when the camera is not in use for an extended period of time, because the battery deteriorates and may cause damage to the contact points of the battery chamber.
- To prevent mildew on the camera, storage should be located in a cool, well-ventilated area.
- Gases from insecticides such as naphthalene may also harm the camera.
- Never wipe with solvents such as thinner or alcohol.
- Periodical performance checks at least once a year are recommended to maintain your camera in good working condition. If you have not used your camera over a long period of time, or when important pictures are planned on an assignment, a pre-check and/or trial shooting is suggested.
- To remove dust on the lens and viewfinder eyepiece, use a blower, followed by the application of a lens cleaning brush. Smudges such as finger prints should be carefully wiped with a clean soft cloth with a few drops of a lens cleaning fluid available on the market. Wipe the lens surface gently from the center towards the edges in a spiral.

TROUBLE SHOOTING

Problems	Remedies
The mirror is stopped partway up.	When the battery power becomes insufficient, the mirror will stop partway up. Reset the mirror by pressing the safety device release button, then replace the battery. Please refer to Page 4.
TTL Pentaprism's exposure meter does not function. (Needle does not move.)	Is the power switch on? The TTL Pentaprism's power switch turns off automatically approximately 30 seconds after it is turned on. There are some other causes. Please refer to the operating manual for the TTL Pentaprism.
The shutter cannot be released without loading film.	The shutter mechanism of the 67 is designed to be disengaged when a film is not loaded. Please refer to Page 10.
Focus is not precise in the picture.	Did you set the pressure plate according to the film type? Film drag or imprecise focusing will occur, if the pressure plate is set contrary to the film type you are using.
Film is not wound smoothly.	Did you set the pressure plate correctly? Since the thickness differs between the 120 type and 220 type, film drag will occur when the pressure plate is set to 220 while using the 120 type film.

Problems	Remedies
The first frame (or the last frame) was cut off on the film.	Did you set the film mark properly? Otherwise, the first (or the last) frame is cut off.
There are some light fog on the film edges.	If the film is wound loosely, accidental exposure may happen when loading or unloading the film. Please refer to Page 20.
The shutter opens up and does not close for a long time.	Did you set the shutter dial at a click properly? The shutter will not close when the shutter dial is set anywhere between the clicks. Please refer to Page 23.
In flash photography, some part of a frame was not exposed.	Did you set the shutter speed at X (1/30 sec.) or slower? Please make sure to connect the synchro cord to the X-terminal. Please refer to Page 32.

INTERCHANGEABLE LENSES

● Lens		● Lens construction (Groups-Elements)	● Diaphragm	● Angle of view	● Minimum focusing distance (m.)	● (ft.)	● Minimum aperture	● Maximum diameter (ømm)	● Length (mm)	● Weight (g.)	● (oz.)	● Filter size (mm)	● Remarks
SMC Pentax Fish-Eye	35mm f:4.5	7-11	FA	180	0.45	1.5	22	102	73	900	31.7	=	
SMC Pentax	45mm f:4	8-9	FA	89	0.37	1.2	22	91.5	57.5	485	17.1	82	
SMC Pentax	55mm f:4	7-8	FA	78	0.35	1.2	22	92.5	78.5	725	25.5	77	
SMC Pentax	75mm f:4.5	4-5	FA	61	0.70	2.3	22	91.5	81	560	19.7	82	
SMC Pentax Shift	75mm f:4.5	8-9	M	61	0.70	2.3	32	97	106.5	950	33.5	82	
SMC Pentax	90mm f:2.8	5-7	FA	53	0.65	2.1	22	91.5	49	480	17.1	67	
SMC Pentax	105mm f:2.4	5-6	FA	46	1.00	3.3	22	91.5	60	590	20.8	67	
SMC Pentax Soft	120mm f:3.5	3-4	M	40.5	0.75	2.5	22	89	63.5	520	18.3	77	
SMC Pentax Macro	135mm f:4	3-5	FA	36.5	0.75	2.5	32	91.5	95	620	21.8	67	
SMC Pentax	165mm f:2.8	5-6	FA	30	1.6	5.3	22	91.5	98.5	830	29.2	67	-

Soft... Soft focus

LS... Leaf shutter built in

FA... Fully automatic

M... Manual

ND... Controlled by ND filters

=... UV, Y2, O2 & R2 filters built in

=... Skylight, Y2 & R2 filters built in

ED... Extra-low Dispersion

IF... Inner Focus

*... Hood built in

● Lens		● Lens construction (Groups-Elements)		● Diaphragm	● Angle of view	● Minimum focusing distance (m.)	● (ft.)	● Minimum aperture	● Maximum diameter (φmm)	● Length (mm)	● Weight (g.)	● (oz)	● Filter size (mm)	● Remarks
SMC Pentax LS	165mm f/4	4-5	FA	30	1.6	5.3	32	92.5	77	780	27.5	77		
SMC Pentax	200mm f/4	4-5	FA	25	1.5	4.9	32	92.5	135	795	28.0	77		
SMC Pentax	300mm f/4	5-5	FA	17	5.0	16.4	45	93	186	1,430	50.0	82	+	
SMC Pentax M*ED (IF) 400mm f/4		9-9	FA	12.5	2.8	9.2	45	133	305	3,700	130.3	67	+	
SMC Pentax	500mm f/5.6	4-4	FA	10.2	8.0	26.2	45	107	398	3,200	112.7	95	+	
SMC Takumar	600mm f/4	5-6	M	8.5	12.0	39.3	45	170	370	6,000	211.3	77	+	
SMC Pentax M*ED (IF) 800mm f/6.7		8-9	FA	6.4	8.0	26.2	45	150	565	6,500	228.9	67	+	
SMC Takumar	800mm f/4	6-6	M	6.4	20.0	65.6	45	236	611	17,700	623.2	77	+	
SMC Reflex Takumar	1000mm f/8	6-9	ND	5.1	35.0	114.8	-	180	352	6,600	232.4	≈77	+	

WARRANTY POLICY

All Pentax cameras purchased through authorized bona fide photographic distribution channels are guaranteed against defects of material or workmanship for a period of twelve months from date of purchase. Service will be rendered and defective parts will be replaced without cost to you within that period, provided your camera has not been abused, altered, or operated contrary to instruction. Because the tolerances, quality, and design compatibility of lenses other than Pentax lenses are beyond our control, damage caused by use of such lenses will not be covered by this warranty policy. The manufacturer or its authorized representatives shall not be liable for any repair of alterations except those made with its written consent and shall not be liable for damages from delay or loss of use or from other indirect or consequential damages of any kind, whether caused by defective material or workmanship or otherwise; and it is expressly agreed that the liability of the manufacturer or its representatives under all guarantees or warranties, whether expressed or implied, is strictly limited to the replacement of parts as hereinbefore provided.

PROCEDURE DURING 12-MONTH WARRANTY PERIOD

Any Pentax camera which proves defective during the 12-month warranty period should be returned to the dealer from whom you purchased your camera or to the manufacturer. If there is no representative of the manufacturer in your country, send your camera to the manufacturer, with postage prepaid. In this case, it will take a considerable length of time before your camera can be returned to you owing to the complicated customs procedures. If your camera is covered by warranty, repairs will be made and parts replaced free of charge, and your camera will be returned to you upon completion of servicing. If your camera is not covered by warranty, regular charges of the manufacturer or of its representatives will apply. Shipping charges are to be borne by the owner. If your Pentax camera was purchased outside of the country where you wish to have it serviced during the warranty period, regular handling and servicing fees may be charged by the manufacturer's representative in that country. Notwithstanding this, your Pentax camera

returned to the manufacturer will be serviced free of charge according to this procedure and warranty policy. In any case, however, shipping charges and customs clearance fees are to be born by the owner. To prove the date of your purchase when required, please keep the receipts or bills covering the purchase of your camera for at least a year. Before sending your camera for servicing, please make sure that you are sending it to the manufacturer's authorized representatives or their accredited repair shops, unless you are sending it directly to the manufacturer. Always obtain a quotation for the service charge, and only after you accept the quoted service charge, instruct the service station to proceed with the servicing.

This warranty policy does not apply to Pentax cameras purchased in the U.S.A., U.K., or Canada. The local warranty policies available from Pentax distributors in those countries supersede this warranty policy.

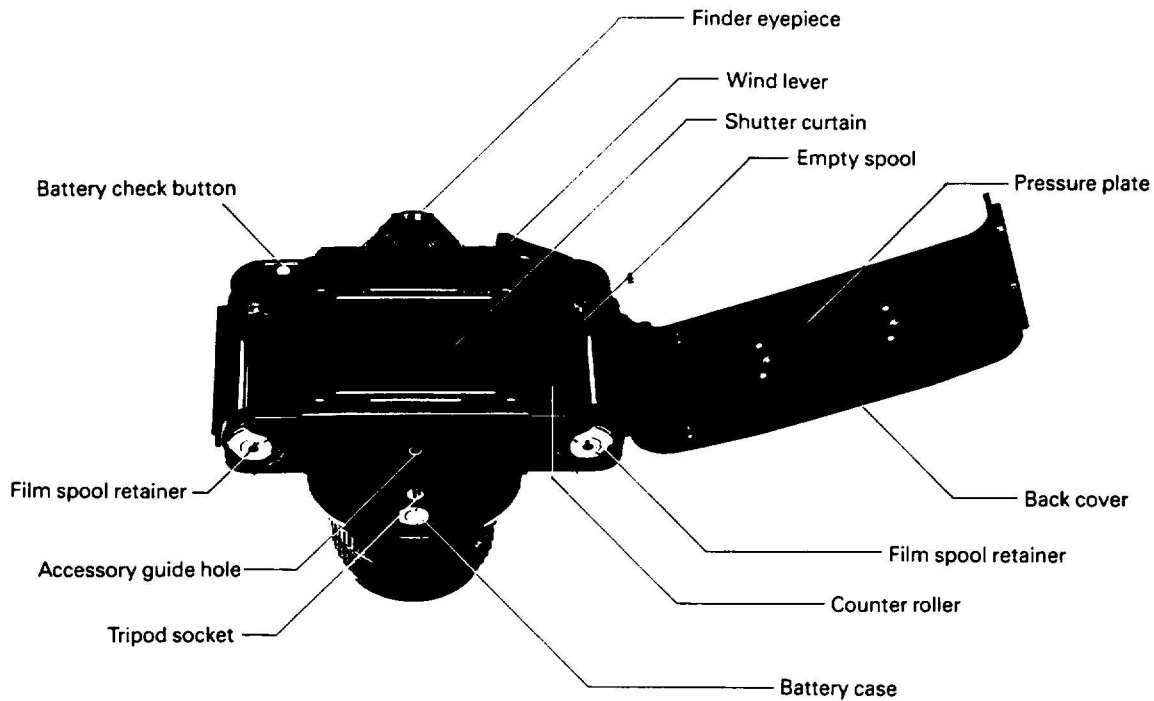

SPECIFICATIONS

Type:

6x7 format Single-Lens-Reflex camera

Film:

120 type roll film (10 exposures)

220 type roll film (20 exposures)

Picture Size:

55mm x 70mm

Lens Mount:

Pentax 67 double bayonet mount system
(Inner bayonet and Outer bayonet)

Shutter:

Electronically controlled focal plane shutter

Viewfinder:

Four types interchangeable viewfinders
(Option) Field of view: Body — 100%, Eye-level type (TTL Pentaprism, Pentaprism) — Approx. 90%, Magnification — 1.0 X, Diopter — -1D

Focusing Screen:

Microprism type (Interchangeable)

Mirror:

Swing-up-and-back instant return mirror, with lock-up device

Film Winding:

With rapid wind lever (180° angle)

Exposure Counter:

Automatic reset exposure counter

Flash Synchronization:

FP and X terminals

Electronic flash at 1/30 ~ 1 sec., B

Power Source:

6V Alkaline or Silver-oxide battery
(4LR44/A544, 4SR44/544/PX28)

Size and Weight:

Body only — 177(W) x 101(H) x 91(D)mm
(7.0" x 4.0" x 3.6") 1.29 kg (2.8 lb)

With TTL Pentaprism — 177(W) x 150(H) x 91(D)mm
(7.0" x 5.9" x 3.6") 1.81 kg (4.0 lb)

Accessories:

Body mount cap, Finder cap, Strap, Spool, Shutter cocking key and battery

SPECIFICATIONS ARE SUBJECT TO CHANGE AT ANY TIME WITHOUT NOTIFICATION OR ANY OBLIGATION ON THE PART OF THE MANUFACTURER.



Asahi Optical Co., Ltd. 11-1, Nagata-cho 1-chome, Chiyoda-ku, Tokyo 100, JAPAN
Pentax Europe n.v. Weveldlaan 3-5, 1930 Zaventem, BELGIUM
Pentax Handelsgesellschaft mbH. Julius-Vosseler-Strasse, 104, 2000 Hamburg 54, GERMANY
Pentax U.K. Limited. Pentax House, South Hill Avenue, South Harrow, Middlesex HA2 0LT, U.K.
Pentax France Z.I. Argenteuil, 12, rue Ambroise Croizat, 95106 Argenteuil, FRANCE
Pentax Benelux (for Netherlands) Spinveld 25, 4815 HR Breda, NETHERLANDS
(for Belgium & Luxemburg) Weveldlaan 3-5, 1930 Zaventem, BELGIUM
Pentax (Schweiz) AG Industriestrasse 2, 8305 Dietlikon, SWITZERLAND
Pentax Scandinavia AB Falhgagsleden 57, 75127 Uppsala, SWEDEN
Pentax Corporation 35 Inverness Drive East, Englewood, Colorado 80112, U.S.A.
Pentax Canada Inc. 3131 Universal Drive, Mississauga, Ontario L4X 2E5, CANADA
Asahi Optical Brasileira Ind. e Com. Ltda. Rua Estados Unidos, 1053, São Paulo, BRAZIL