

Mamiya RB67 Pro-S

FILE COPY
PHOTOCOPIED FOR YOU

Instructions



CONTENTS

Congratulations on your wise decision to purchase this Mamiya RB67 Camera!

Perusing this manual before attempting to use the RB67 will assist in correct camera operation and will minimize the possibility of malfunctions.

The Mamiya RB67 is one member of a unique "camera family" developed by the Mamiya Camera Company, a recognized world leader in large-format photography. The RB67 takes its place alongside the famous Mamiya C Professional and the Mamiya Press Cameras.

Versatility of the Mamiya RB67, embodying fine performance and various capabilities, results in a large format camera that meets and satisfies all requirements of the advanced amateur as well as the professional photographer, offering the means of producing top-grade pictures in all fields including general commercial, industrial, scientific, and news photography. Its interlocking with many Mamiya Press camera accessories further widens the range of the RB67's photographic application.

Specifications	1
Features	2
Names of Parts and Outline of Operating Method	6
Operating Instructions	11
Attaching and removing the lens	12
Shutter cocking/Shutter release button	13
Operating the focusing hood	14
Horizontal and vertical picture format selective operation	15
Attaching and detaching the roll film holder	16
Loading and advancing the roll film	18
Multiple exposure photography	21
Setting the shutter speed and the aperture/Time operation	22
Focusing knob fixing operation/ Distance scale	23
Depth-of-field/Using a tripod	24
Close-up photography	25
Close-up photography with auto extension tubes	26
Flash photography	28
Mirror-up photography (Independent mirror release)... ..	29
Lens hood/Carrying strap	30
Changing the magnifier/Focusing hood	32
Changing the focusing screen/Revolving adapter	33
Lock system of the camera back (attaching system)... ..	36
Mamiya RB67 operation diagram	38
Special pointers in using the Mamiya RB67 Pro-S	39
Lenses	40
Accessories	47

❑ Specifications of Mamiya RB67 Pro-S

Camera Body

Type:

6 x 7cm lens-shutter type, single-lens reflex camera

Lens mount:

Bayonet mount (with safety lock ring)

Viewfinder:

Horizontal format index mark interlocks with revolution of revolving adapter (Vertical format based on fixing index line on focusing screen.)

Focusing hood:

Single-action opening and closing, with mounting lock.

Interchangeable.

Finder magnification is 2.5X.

Magnifier is also interchangeable.

Focusing screen:

With fresnel lens Interchangeable

Revolving adapter (exclusively for Pro-S):

Vertical and horizontal positions revolving up to full 90° rotary system, with format indication interlocking mechanism.

By R-lock system, interchangeable with other adapters.

By G-lock system of revolving adapter, G-lock-type film holders are attachable.

Focusing:

Bellows extension system with rack pinions.

Maximum extension 46mm. With focusing knob fixing device.

Shutter and mirror cocking:

Single-action [75°] cocking by lever on camera body side.

Others:

Accessory shoe is provided.

Shutter release button can be locked to prevent releasing the shutter accidentally

Standard Lenses:

Mamiya Sekor 90mm f/3.8 with lens hood

Mamiya Sekor 127mm f/3.8 with lens hood

Filter screw diameter: 77mm

Aperture: Full automatic diaphragm (with depth-of-field preview lever). f/3.8 to 32 (with click-stop for half-step aperture settings).

With mirror-up photographing feature (independent mirror release) device.

Shutter:

Seiko # 1 shutter

1 to 1/400 second and T (Time)

Flash synchronization:

M-X full synchronization

Pro-S 120 Roll Film Holder

Film used:

120 roll film 10 exposures; 6 x 7cm format

Actual negative size:

56 x 68.4mm

Film advance:

One-stroke lever film advance (After 70° winding, can be wound in several short, definite strokes)

Automatic double-exposure prevention.

Film wind stop automatic release.

Multiple exposure is obtainable optionally.

Film counter:

Automatic resetting type; Red index mark disappears upon completion of film winding.

Provided with dark slide dislocation preventive device and memo clip.

Dimensions:

(Camera body with roll film holder)

Height: 5-21/32in. (144mm)

Width: 4-3/32in. (104mm)

Length: 8-31/32in. (228mm)

(with 90mm f/3.8 lens)

8-17/32in. (217mm)

(with 127mm f/3.8 lens)

Weight:

Camera body with revolving adapter and focusing hood 3 lbs., 3-2/16 oz. (1450g)

Pro-S roll film holder 15-14/16 oz. (450g)

90mm f/3.8 lens 28-6/16 oz. (805g)

127mm f/3.8 lens 26-7/16 oz. (750g)

◆ Features of Mamiya RB67 Pro-S

The Mamiya RB67 Pro-S is a unique, high-grade, 6 x 7cm lens-shutter type, single-lens reflex camera developed to offer excellent picture quality and easy handling. Mamiya feels confident that the extensive versatility and capabilities of the Pro-S will meet and satisfy the requirements of all photographers.

1. Rational 6 x 7cm format

Since the 6 x 7cm format covers an area 4.5 times the 35mm format, excellent picture quality is obtainable. Especially, it demonstrates superb results in color photography. The ratio between the length and width of 6 x 7cm formats is almost the same as that of large photographic paper, permitting economical enlargements without cropping.

When designing a magazine layout, a sufficient blank space is reserved for headlines and explanatory notes, so that the entire picture format can be fully utilized.

2. Single-lens reflex camera offering a bright, large finder image

Since parallax-free focusing is the outstanding feature of the single-lens reflex camera, speedy camera operation is possible through brilliant, precise 6 x 7cm picture composition.

3. Excellent Mamiya Sekor lenses

Mamiya Sekor lenses boast excellent image rendition and color balance. Various types ranging from wide-angle lenses to telephoto lenses are available.

These lenses are rationally grouped in series, whereby those exactly adaptable to one's particular photographing objectives are optionally selectable with ease.

4. Lens-shutter system suitable for electronic flash photography

By adopting the lens-shutter system, electronic flash is synchronized with all shutter speeds, making it possible to produce highly impressive photographs.

5. Double-exposure prevention and multiexposure devices

An interlocking device for double-exposure prevention is incorporated in the Pro-S roll film holder. Since this device is interlocked with the Pro-S body mechanism, the shutter cannot be released unless the film is advanced. Also, film advance for the next exposure is impossible unless the shutter is released.

When the shutter is released, the film wind-stop is automatically released.

Multiple exposure photography is available simply by switching a lever.

6. Vertical or horizontal picture format quickly changed over with the revolving adapter

A revolving adapter is provided as a standard outfit, whereby the vertical or horizontal picture format is promptly selected by turning the camera body back by 90°. without changing the camera position.

This is especially convenient when the camera is mounted on a tripod.

7. Finder format index interlocked with revolving adapter

When the revolving adapter is turned up to 90°| horizontal format picture index red lines appear (or disappear), presenting proper picture composition.

8. Excellent film flatness ensured by Pro-S roll film holder

Various tests have been applied to the Pro-S roll film holder to stabilize film flatness. As a result, film flatness has been further improved.

9. Camera back adapter changeable according to photographing objectives

By changing the back adapter, depending on your photographic objective, the range of film applications can be widened to include 120 and 220 roll films, dry plates, cut films,

and 70mm film.

The film holders and back adapters are very easily exchanged.

10. Unique mirror shockless mechanism

By adopting a unique centrifuged friction governor system, the mirror functions smoothly without sensing shocks. Mirror shock, constituting the most important problem involved in large, single-lens reflex cameras, has been solved.

11. Large variety of finders

A big selection of finders conforming to your photographic objective are available.

They include a CdS finder (appropriate exposure obtainable with Through-the-lens measuring system), a Prism finder (subjects can be seen as an erect image), a CdS prism finder (former two types of finders are combined), a Magnifying hood (easily visible and bright), a Dual magnifying hood (performs precision focusing by speedily changing the magnifier of high magnification), and a Universal sportsfinder (permits focusing on the focusing screen after it has been installed).

The focusing screens are also easily exchangeable. Depending

on the photographing objectives, a checker, a rangefinder spot, a microprism, and a cross-hair can be selected at your option.

12. Excellent heat- and cold-resistant capacity

Camera component parts are capable of demonstrating their functions within a wide temperature range from approximately 120°F to - 5°F (50°C to - 20°C)

The lens-shutter maintains accurate function, even in severe cold, and shutter speed deviation is negligible. Its resistivity to coldness is superb.

Although the camera operating unit grows sluggish at or below 15°F (- 10° C), it is sufficiently capable of operating the camera until the temperature drops to approximately - 50° F (- 20° C).

13. Mirror-up photography (independent mirror release) possible

When sharp pictures are demanded, the mirror-up mechanism plays a big role. When taking a picture unhurriedly with the camera mounted on a tripod. or when photographing at slow shutter speeds or using a telephoto lens, the mirror-up operation merit is highly effective.

14. Close-up photography through full use of bellows characteristic features

Since the bellows can be extended up to 46mm, photographing small subjects in the frame full size is possible. When auto extension tubes are used, the subject can be further enlarged. When a standard lens is employed, life-size (1 :1) or larger pictures can be photographed.

15. Single-action focusing hood

Available as a standard outfit is a collapsible focusing hood, which can be opened and closed by single action, and which can be shielded from extraneous light by raising the magnifier. Depending on diopter of your eyes, the magnifiers are interchangeable. A double-lock mechanism prevents the focusing hood from accidentally slipping off.

16. Focusing knob fixing device

A focusing knob fixing device is provided so that the focusing knob will not be moved inadvertently during close-up photography, taking snapshots, fixed focus photography, or using a telephoto lens.

17. Dark slide lock for safety while carrying

A dark slide lock is provided for the Pro-S roll film holder so that the dark slide will not slip off while carrying the holder detached from the camera body.

16. Accessory shoe

An accessory shoe is provided for convenient use when mounting the clip-on-type flash unit.

19. Unique safety devices

Various safety devices eliminate possible photographic failures.

20. Complete set of accessories

Availability of a complete set of various accessories further augments photographic possibilities and camera versatility.

Names of Parts and Outline of Operating Method

Shutter cocking lever

Both the shutter and the mirror are cocked by this lever. Unless they are set, a safety device prevents the shutter release button from being depressed.

Dark slide

When this dark slide is inserted, a safety device prevents the shutter release button from being depressed. (Draw out the dark slide before taking a picture)

Mirror

Distance graduation

Distance scale

Shutter release lock ring

When this ring is aligned with the orange dot, a safety device prevents the shutter release button from being depressed. (Align the ring with the white dot before taking a picture.)

Shutter release button

When the camera and the roll film holder are not ready for photography, a safety device prevents the shutter from being released.

Nameplate

By sliding this nameplate, the focusing hood can be exchanged.

Focusing hood latch

This latch prevents the focusing hood from slipping off by carelessly moving the nameplate.

Lens mounting index mark (red dot)

Bayonet ring

The lens is clamped to the camera body by this ring. When the mirror is not cocked, a safety device prevents the lens from being removed.



Single-action focusing hood 12

Opening and closing is performed by Single action. Extraneous light shielding design is adopted for this focusing hood.

Focusing screen 13

This screen is interchangeable with various types. Being interlocked with the revolving adapter, horizontal picture format index lines appear under the screen.

Carrying strap lug 14

Accessory shoe 15

Dark slide storing lug 16

Focusing knob 17

Focusing knob fixing lever 18

19 Magnifier setting lever

By moving this lever to the left, the magnifier can be set. By pressing down the magnifier base plate, the magnifier can be hooked in place

20 Magnifier

The magnifier is interchangeable with other diopter lenses.

21 Focusing hood mounting prongs

22 Film advance lever

Unless the film is loaded and advanced, a double-exposure preventive device prevents the shutter from being released. Unless the shutter is released, the film cannot be advanced, thus preventing idle film advance.

23 Multiexposure lever

When multiple exposure is desired, or when you want to release the shutter without loading the film, it can be achieved by moving this lever to the front until the red mark becomes visible.

24 Memo clip

By storing the separated film box cover or white paper sheets here, memos can be entered

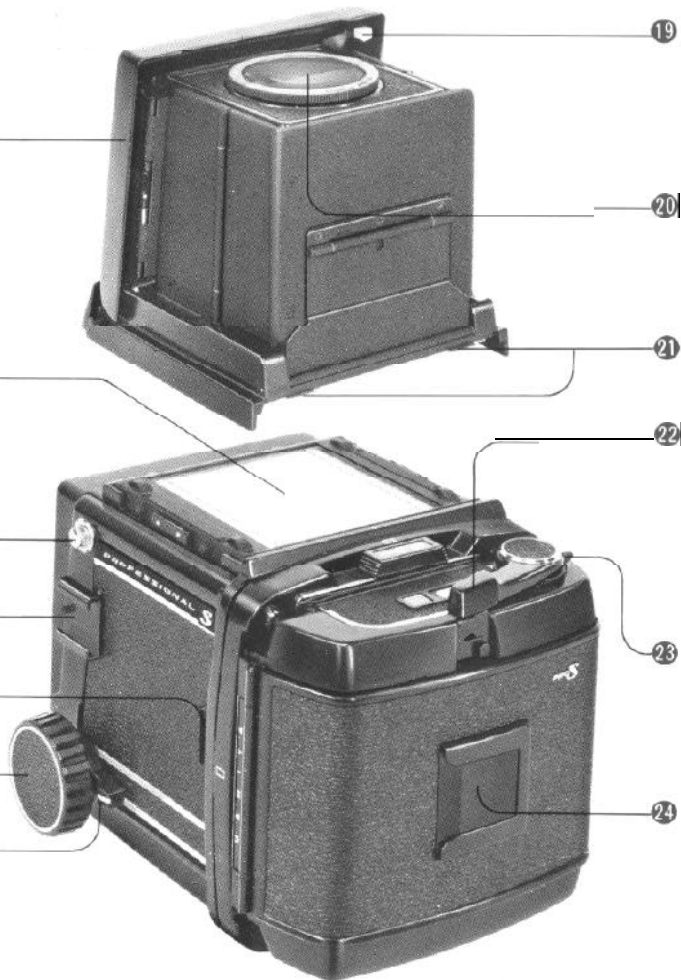

Coupling pin for film wind-stop releasing

When the shutter is released, the film wind-stop is automatically disengaged by this pin, allowing subsequent film advances.

Light baffle

Do NOT touch this light baffle with your fingers.

Revolving adapter

Turning this adapter up to 90° permits change-over between the horizontal and vertical picture format.

R-lock lever

Use this lever to attach and detach the revolving adapter

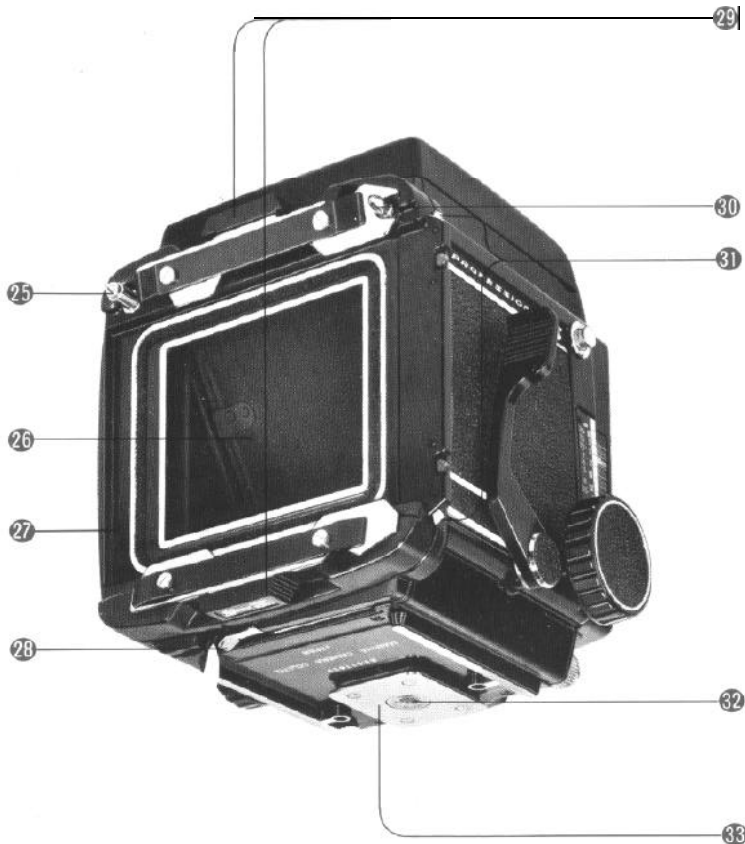

Slide lock for G-lock type holder

Use this lock to attach and detach a film holder. When the dark slide is not inserted in the attached roll film holder, a safety device prevents the holder from being detached.

Coupling pin for multi-exposure prevention

Release lever for slide lock

When detaching a film holder other than the roll film holder, or when the slide lock is locked, move the slide lock to the left while pressing this release lever.

Tripod socket

This socket is applicable to a U 1/4-inch tripod screw. By removing the inner socket, a tripod with a 3/8-inch tripod screw can be used.

Tripod mounting base

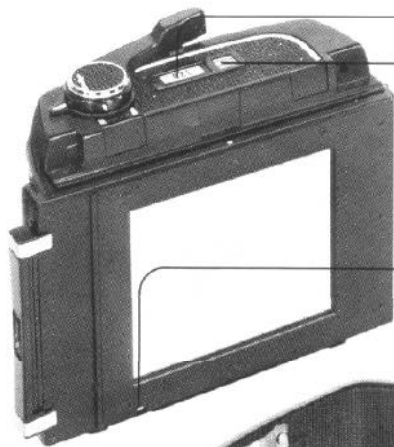

Pro-S Outer Cassette

38 Film type index (120 or 220)

39 Exposure counter

When the film is advanced and the shutter is released, a red mark appears on the side of the counter digits. When the next film advance is completed, the red mark disappears. The red mark also appears while the film is being advanced from S to 1.

40 Safety-catch for dark slide

When the film holder is being carried about after detaching it from the camera body, this safety device prevents the dark slide from accidentally slipping off.

When the film holder is attached to the camera body, the dark slide can be removed automatically.

Back cover 44

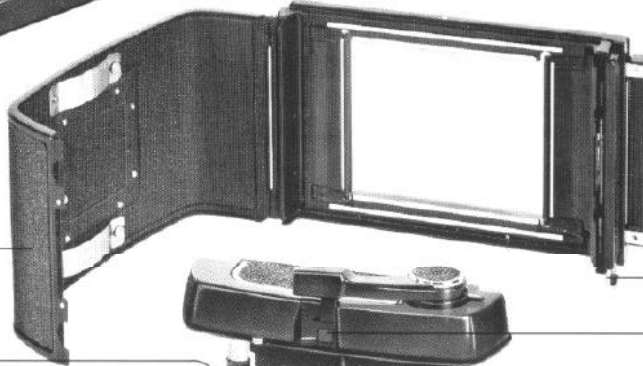

41 Back cover latch

Film spool stud 35

Load a film so that the leader paper is pulled out along the guide mark.

42 Film wind-stop release lever

The film wind-stop is released manually by this lever only when the Pro-S roll film holder is used for the Mamiya Press.

Guide mark for leader paper 36

Starting mark 37

Wind the film advance lever until the leader paper starting mark is aligned with this mark. After closing the back cover, by winding the lever several strokes, it will stop at the first exposure position.

43 Spool release pin

A film spool is attached and detached by pressing down this pin.

44 Take-up spool stud

After inserting the take-up spool, the leader paper is inserted on the spool.

Pro-S Film Insert

M-X selector

This selector is switched while depressing it.

Synchroflash terminal

Depth-of-field preview lever

Distance scale lever for depth-of-field reading

Cocking position marks

Mirror release operating knob

To effect mirror-up photography, pull out and turn the knob clockwise and set it to the MIRROR-UP index, then attach a cable release to the knob. At first, raise the mirror and the light baffle by depressing the shutter release button, then release the shutter by pressing the cable release attached to the knob.



51 Aperture scale ring

52 Shutter speed ring

53 Depth-of-field scale

54 Distance scale for depth-of-field reading

45

46

47

48

55

Shutter release lock pin

The shutter can be released by turning the shutter cocking pin clockwise while pressing the lock pin.

49

50

56

Shutter cocking pin

When cocking the shutter with a finger, turn the cocking pin up to the red dot.

□ Attaching and Removing the Lens

● Attaching the Lens

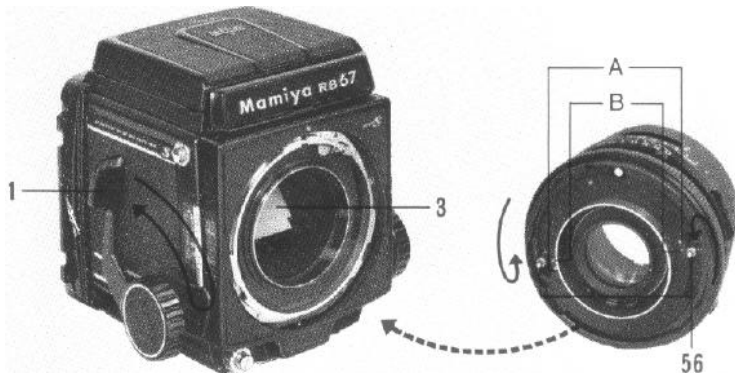

After cocking the camera body mirror and the lens shutter, mount the lens on the camera body.

Cocking the Mirror of Camera body

1. Remove the front body cap from the camera body.
2. Be sure that the mirror (3) is in the cocked, down position in the camera body, shielding the camera film plane from exposure to light.
If the mirror is up, cock the mirror by fully pushing down the shutter cocking lever (1) toward the front of the camera.

NOTE: If the camera is placed with its back facing downward when attaching or removing the lens, without mounting the rear body cap or the film holder, the coupling mechanism may be damaged. Always pay attention to this caution.



Attaching the Lens

1. Turn the bayonet ring (11) counterclockwise, and align the red dot on the bayonet ring with the triangular mark at the center.
2. Mount the lens, keeping the triangular mark aligned with the lens mounting mark (10); then firmly twist the bayonet ring clockwise. Now, the camera and lens have been set.

Cocking the Lens Shutter

1. Remove the rear cap of the lens.
2. Cock the lens shutter. Firmly turn the shutter cocking pins (56) with your fingers to the red dots (A) of the cocking position marks. Now the shutter blades are open.
*When removing your fingers from the pins, the cocking pins will turn back to the green dots(B).
* If the cocking pins are not fully turned to the red dots (A), the shutter will not be completely cocked.
* After removing the lens from the camera body, the shutter is always cocked.

Shutter Cocking

• Removing the Lens



Remove the lens while the mirror and the shutter are cocked.

Turn the bayonet ring (11) counterclockwise, aligning its red dot with the lens mounting mark (10) on the body, and remove the lens.

If the mirror and the shutter are not cocked in this instance, the lens cannot be removed, because turning the bayonet ring will be intercepted by action of the safety interlock mechanism.

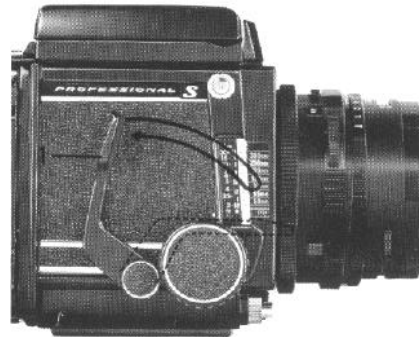

Press down the shutter cocking lever (1). The shutter in the mounted lens and the mirror in the camera body are cocked simultaneously. The lever will return to its original position by self-action.

* When shutter cocking is not completed, the shutter cocking lever will not return to its original position.

* Once the shutter is cocked, the cocking lever will not move until the shutter is released by pushing the shutter release button. Therefore, when the cocking lever will not move, you know the shutter is cocked.

Shutter Release Button

• Disengaging the release lock of the shutter release button

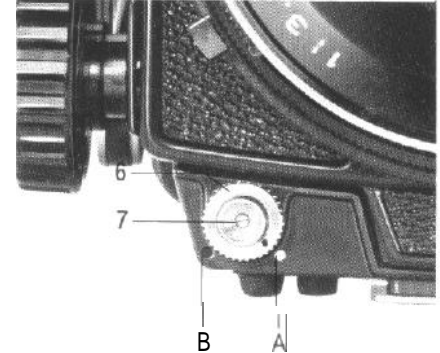

This safety mechanism is designed to prevent accidental release of the shutter while carrying the camera in its case.

When the shutter release lock ring (6) is turned and the index mark is aligned with the white dot (A) on the body, the shutter release button (7) can be pressed.

When the index mark is aligned with the orange dot (B), the shutter release button cannot be pressed.

• Releasing the shutter

When the shutter release button is pressed, the mirror is pushed up and the shutter is released.

* If the mirror is not cocked, the shutter release button cannot be depressed.

* The socket inside the shutter release button is threaded so that a cable release or a self-timer can be easily attached.

◆ Operation of Focusing Hood

● Raising the focusing hood

By raising the back side of the hood, the entire focusing hood will automatically spring into position.

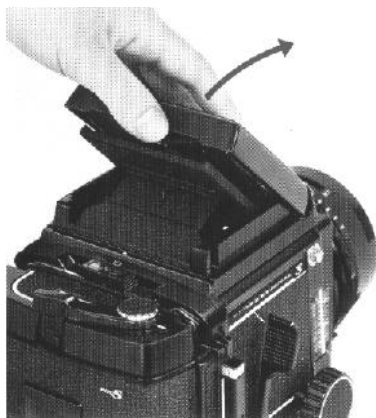

● Raising the magnifier

By sliding the magnifier setting lever (19) to the left, the magnifier will automatically pop up.

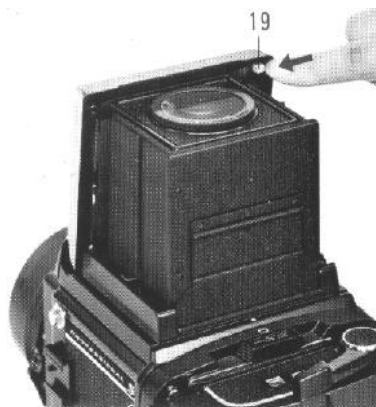

● Folding the focusing hood

With the magnifier in its closed position, fold down the front and back panels of the focusing hood, whereby the entire focusing hood is collapsible.

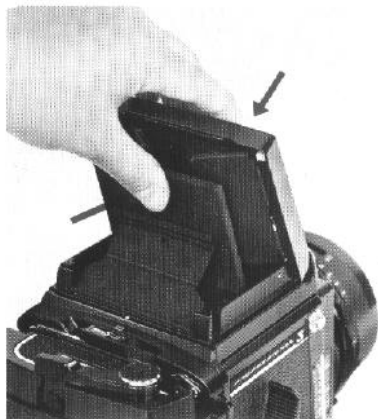

● Folding the magnifier

By pressing down the base plate of the magnifier, the magnifier will hook in place.

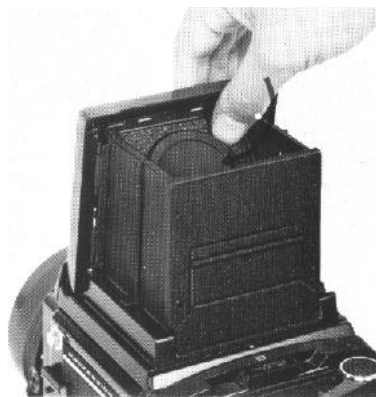

❑ Changing the Picture Format to Horizontal or Vertical

- Operating the revolving adapter



When the horizontal format mark of the revolving adapter is facing upward, a horizontal format will result. To compose a vertical photograph, turn the revolving adapter clockwise until it stops. To change from vertical to horizontal, turn the revolving adapter counterclockwise.

In either case, be sure to turn the adapter a full 90° until it clicks and stops. If the adapter is stopped midway, the shutter release button cannot be pressed.

* Do NOT turn the revolving adapter while the shutter release button is being pressed. Especially, when a cable release or a self-timer is used, and adjustment of the release tip is improper, the shutter release button will remain depressed after the shutter is released. Always pay attention to this fact.

- Viewfield of horizontal or vertical format



Horizontal picture format

When the revolving adapter is positioned at the horizontal format, red lines appear on the ground glass focusing screen to indicate a horizontal picture format. Compose the picture within the red lines.



Vertical picture format

When the revolving adapter is positioned in the vertical format, the red lines disappear. Compose the picture within the broken lines on both sides.

◆ Attaching and Detaching the Roll Film Holder

● Removing the rear body cap

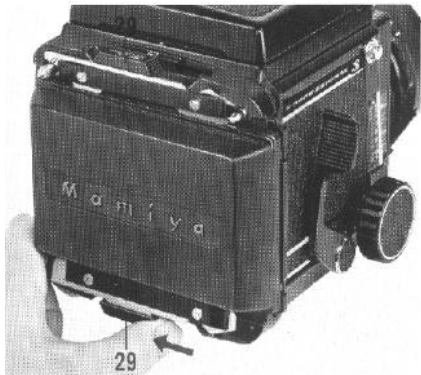

By moving the slide locks (29) on both sides fully to the left, the cap can be removed.

* Never push the light baffle (26) on the camera back after removing the rear body cap. If the light baffle is pushed by force, it will cause light leakage or a malfunction.

● Attaching the roll film holder

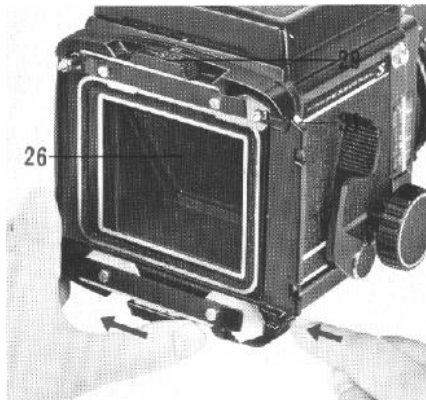

1. Before attaching the holder, confirm that the upper and lower side slide locks (29) are on the left end of the indented portion when viewed from behind the camera body.

NOTE:

Should either slide lock be moved to the right while nothing is attached to the revolving adapter, the slide lock release lever (31) will engage and the slide lock will not move. If this happens, press the release lever (31) and return the slide lock to the open position.

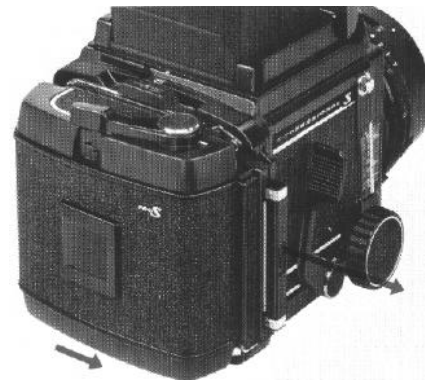

2. Attach the roll film holder and slide both slide locks firmly in the direction of the arrow mark.

⚠ If the slide lock of the revolving adapter is not pushed fully in or out, the shutter will not be released because of the shutter locking safety device. Always operate the slide lock securely.

⚠ If closing the lower slide lock is neglected, the safety device of the Pro-S holder will prevent the dark slide from being removed.

⚠ If the dark slide is completely inserted, or if the film is not loaded, the shutter release button cannot be pressed, leading to picture-taking failure.

● Detaching the roll film holder



1. Insert a dark slide in the roll film holder. Two white lines on the side of the holder indicate the position of the inserting slit.
2. Remove the roll film holder by sliding both slide locks (29) in the opposite direction to the arrow mark on the slide lock.

- ⌘ If the dark slide is not inserted, the slide lock will be locked by the safety device, and the roll film holder cannot be detached.
- ⌘ When a dark slide is completely inserted, the slide lock release lever (31) is automatically disengaged, and the slide locks can be slid without pressing the release levers.

NOTE:
Since a coupling device for double-exposure prevention is adapted for the Pro-S roll film holder, the shutter cannot be released if the film is not loaded.



When desiring to release the shutter without loading the film.

- In this instance, the shutter can be released by sliding the multiexposure lever of the roll film holder to the front, and by setting the shutter cocking lever and pulling out the dark slide.
- ⌘ When the dark slide is completely inserted, the shutter release button cannot be pressed. Therefore, either remove the dark slide or draw it outward to a position where the entire triangular hole in the top center of the dark slide becomes visible.
 - ⌘ Either operation of the multiexposure lever or the shutter cocking can be initially conducted.

◆ Loading and Advancing the Roll Film

• Loading the film

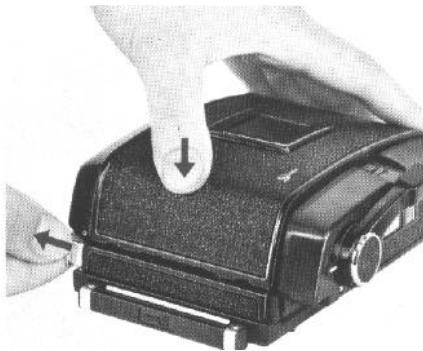

1. Open the back cover by pulling out the back cover latch, while slightly pressing the back cover. Remove the film insert from the holder.

* When loading and unloading film, avoid direct sunlight. Choose a location in the shade.

‡ Regardless of whether the roll film holder is attached to or detached from the camera body, loading and unloading the roll film can be conducted in the same manner

* Use 120 roll film with the 120 roll film holder, and 220 roll film with the 220 roll film holder.

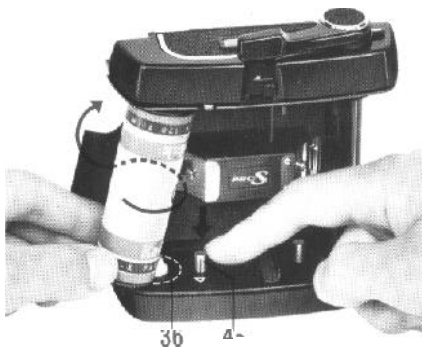

2. While pressing the left side spool release pin (43), insert a new roll of film on the film spool stud.

Load the film so that the leader paper can be pulled out along the arrow of the leader paper guide mark (36). In this way, the black side of the leader paper will appear on the outside.

‡ If the black side does not appear on the outside, reload the film, reversing the film position.



3. Pull out the leader paper and insert the tip into the groove of the take-up spool.

* Position the film so that the leader paper winds evenly between the spool flanges; otherwise the film may be taken up unevenly, causing trouble.

- **Aligning the starting mark**



Move the film advance lever gently, until the starting mark (arrow) of the leader paper aligns with the starting mark of the holder. The film advance lever can be moved in several short, definite strokes.

⚠ If the leader paper is pulled too far, the film may become fogged. Be careful not to go beyond the starting mark (arrow).

- **Attaching the film insert**

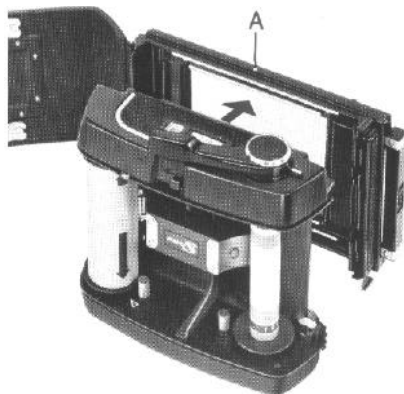

1. Put the insert into the cassette, aligning the top side of the insert with the white dot (A) of the cassette.

* If the film insert is attached in reverse, the back cover cannot be closed.

2. Close the back cover and fully push in the back cover latch while pressing the back cover.

NOTES

1. The outer cassette of the Pro-S roll film holder can be used for both 120 and 220 film inserts.

2. The film insert of the Pro-S roll film holder cannot be attached to the outer cassette of the former RB67 roll film holder.

- **Film winding for first exposure**



By winding the film advance lever until it stops, the figure "1" will appear in the exposure counter (39), the red mark indicating incomplete film winding will disappear, and the film will be positioned for the first exposure

* Unless film winding from S to 1 in the exposure counter is completed, the shutter cannot be released.

● Film advancing



Exposed



Film advance
completed
(Before exposure)

1. Draw out the dark slide and release the shutter. When the shutter is released, the red mark appears in the exposure counter, indicating that the film is exposed.

2. Simultaneously when the shutter is released, the film wind-stop mechanism is automatically disengaged, and the film can be advanced for the next frame. When film is advanced one full frame, the figure in the exposure counter is advanced, and the red mark disappears.

* Unless the exposed film frame is advanced, shutter releasing is prevented by the coupling device for double-exposure prevention.

✎ Shifting to multiple exposure photography is possible. Refer to the next page.

✎ Even though film advance is completed, the shutter cannot be released if return of the film advance lever is hindered by your fingers or by another object.

* Wind the film advance lever in a slow, steady manner to avoid film winding problems.

* Although the film advance lever cannot be reversed until it is wound up to the initial 70⁹ winding, it can be moved in several short, definite strokes thereafter.

* The film wind-stop release lever provided for the Pro-S roll film holder is to be used when the holder is used for the Mamiya Universal Press, or when desiring to wind up to the film end while unexposed film remains in the holder.

3. When you finish exposing the full number of exposures, the shutter release button cannot be depressed and the film advance lever will be freed. Then wind the film completely to the end of the leader paper.

● Unloading the film

1. Open the back cover of the holder and remove the film insert. Press the right side spool release pin (43), remove the full spool, then wrap and seal the film to protect it from loosening.

2. Move the empty spool to the take-up side. The insert is ready for reloading.

* The exposure counter automatically resets to S (start) as soon as the back cover is opened.

✎ When the exposure counter shows other than S, a film is loaded in the holder.

● Film advancing and shutter cocking



Either film advancing or shutter cocking can initially be conducted. However, the recommended sequence of these steps to be customarily observed is: (1) film advancing, (2) shutter cocking, and finally (3) shutter releasing.

◆ Multiple Exposure Photography

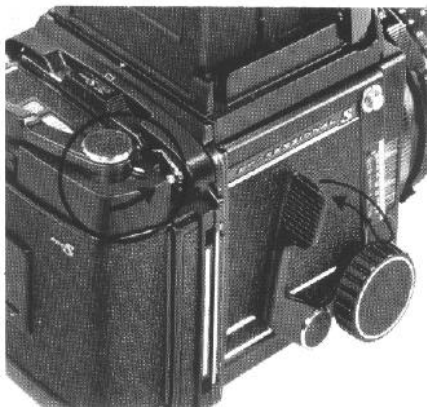

When the multiexposure lever of the roll film holder is moved forward, the coupling pin for double-exposure prevention is disengaged, and whenever the shutter cocking lever is set, shutter releasing can be repeated without limit.

* The multiexposure lever can be changed over before or after shutter cocking, and also before or after shutter releasing for the first multiple exposure photograph.

* When taking multiple exposure pictures is finished, never fail to return the multiexposure lever to its original position; otherwise, failure in taking subsequent multiple exposure pictures will occur.

- When desiring to wind up to the end of film while unexposed film remains in the holder.



When the film advance lever is continuously wound, with the film wind-stop release lever (42) pushed to the left, the film can be reeled up completely to its end, even though picture taking is still in progress and a film remains unexposed.

- Storing the dark slide



While progressing with photography, the dark slide of the roll film holder can be stored by inserting it into the camera body side.

- Memo clip



The clip on the back cover can be used for holding the cover of a film box or a slip of paper to record information.

◆ Setting the Shutter Speed and the Aperture

● Setting the Shutter speed



Align the desired shutter speed with the red dot on the center of the lens barrel.

* Always set the shutter speed to the click stop position. In-between shutter speeds cannot be used.

* If the shutter speed is changed, after cocking the shutter, do not turn the shutter speed ring rapidly.

● Setting the aperture

Align the desired aperture value with the red dot on the center of the lens barrel.

* Adopted for the aperture is a fully automatic diaphragm which stops down during shutter operation.

* The aperture can be set at full and half click stops.

● Time Operation

1. By setting the shutter speed scale on T (time) and releasing the shutter, the shutter will remain open for an extended time exposure.

2. To close the shutter, turn the shutter speed ring toward the 1 sec. mark or press down the shutter cocking lever about 30°.

* Do not move the shutter cocking lever until just before closing the shutter.

* When the shutter is closed by the shutter cocking lever, the light baffle in the camera body drops slightly lower; however, since it is an extended time exposure, fogging over the actual exposure does not occur.

* When the shutter is closed by the shutter cocking lever, the lever is locked by the reverse motion stopper and does not return to its original position. When the shutter is cocked by further depressing the lever, the lever returns to its original position.

❑ Focusing and Focusing Knob Fixing

● Focusing



When the shutter is cocked, the mirror is cocked simultaneously, and an image is visible on the ground glass of the focusing screen. By turning either the left or right focusing knob, adjust the focus and compose the picture.

● Focusing knob fixing

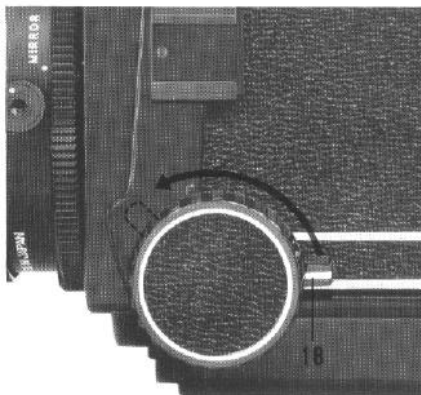

After adjusting the focus, turn the focusing knob fixing lever (18) forward and appropriately clamp it, whereby the focusing mechanism is secured.

⚠ Deviation in focusing can be prevented in this manner, when continuously taking pictures, taking snapshots with wide-angle lenses, close-up photographs, and using telephoto lenses.

◆ Distance Scale

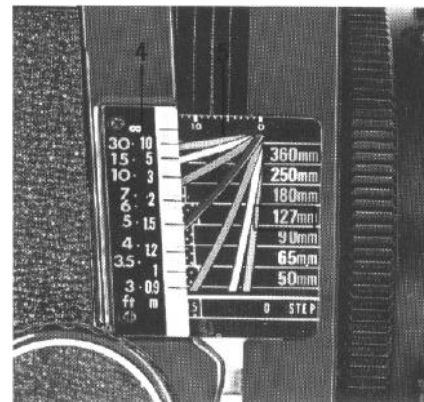

Distance from the film plane to the subject can be determined by the distance scale (5).

Curves on the distance scale are represented in a different color for each lens. The figure on the distance graduation (4) which meets the curve for the lens used after focusing reveals the distance to the subject.

For example, if the distance graduation and the curve are as shown in the photo after focusing with the 127mm lens, you can confirm that distance to the subject is 5ft. (1.5m) by reading the graduation aligned with the orange curve.

◆ Depth-of-field

- Viewing on the focusing screen

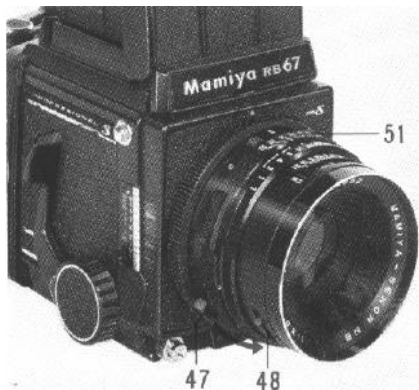

1. Set the desired aperture by turning the aperture scale ring (51); then adjust the focus.
2. Depress the depth-of-field preview lever (47) and the depth-of-field can be observed on the ground glass focusing screen. When removing your finger, the lever will return to its original position and the lens aperture will fully reopen.

- Using the depth-of-field scale

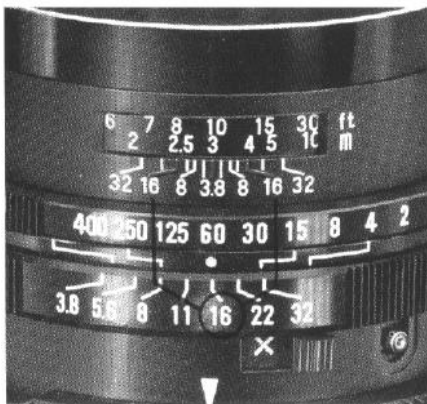

1. Turn the distance scale lever (48) and align the figure representing the focused distance with the center index mark on the depth of field scale (53).
2. The two distances (on both sides of the center index mark) opposite the same figures as the actual lens aperture on the depth-of-field scale are the near and far limits of depth for a given distance and lens aperture.
For example, when photographing a subject 10 feet away with the 127mm lens at an aperture of f/16, objects from about 8 to 13 feet will be in focus.

◆ Using a Tripod

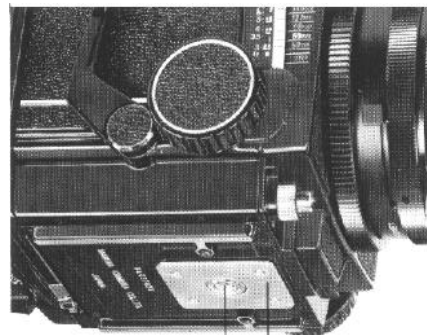

32 33

For maximum picture sharpness the use of a sturdy tripod is recommended. Insert the tripod screw into the tripod socket (32) at the bottom of the camera.

When a tripod with a 3/8 inch tripod screw is used, remove the inner socket by turning the tripod socket counterclockwise with a coin or similar disk inserted in the slots of the socket. The standard tripod has a 1/4 inch tripod screw and can be used for this camera in conjunction with the inner tripod socket.

● Tripod Mounting Base

The tripod mounting base (33) at the bottom of the camera is for attaching a quick shoe. If you keep a quick shoe on your tripod head, the camera can be quickly and easily mounted on it.

Close-up Photography

- Exposure compensation for close-up photography

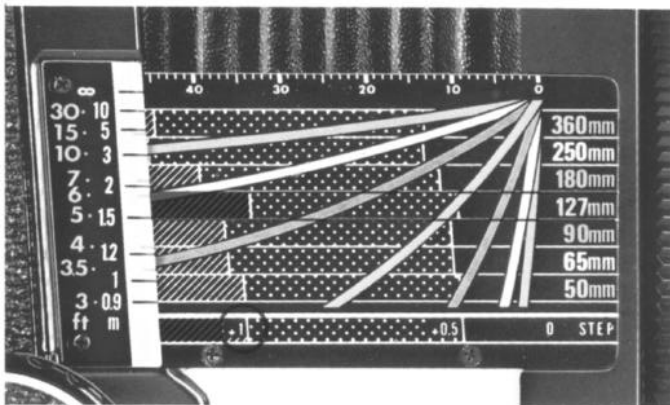

When the lens is extended for close-up photography, and distance between the lens and the film plane increases beyond normal, image brightness on the film plane decreases, requiring an increase in exposure. To adjust the exposure, refer to the exposure compensation scale on the camera body.

1. After adjusting focus on the subject, read the exposure compensation value obtained on the exposure compensation scale.

For example, assume that focus was adjusted with the 127mm lens and the result was as shown in the photo.

Seek the same pattern in the bottom column as the pattern where side panel lines meet the 127mm lens scale. The numerical value of that pattern (+ 1 in this case) is the exposure compensation value.

2. Compensate the exposure by changing either the shutter speed or the aperture.

When the exposure compensation value is + 1, open the aperture one stop, or slow the shutter speed 1 step. For 0.5 step compensation, use the half-stop aperture scale settings.

For example, if your exposure meter shows an exposure setting of (1/60 sec. at f/16), it must be adjusted in the case of the + 1 compensation value to (1/30 sec. at f/16) or (1/60 sec. of f/11).

* When using the CdS finder for the Mamiya RB, exposure need not be compensated, since the meter reads actual exposure directly.

- Maximum close-up photography table (with bellows fully extended)

Lens	Lens-to-subject distance	Magnification	Subject size
50mm f/4.5	1' 15 3/4" (4.9cm)	0.88	2 1/2" × 3 3/8" (6.3 × 7.7cm)
65mm f/4.5	3 3/8" (8.5cm)	0.71	3 3/8" × 3 3/8" (7.9 × 9.7cm)
90mm f/3.8	7 3/4" (20.0cm)	0.51	4 3/8" × 5 5/8" (11.0 × 13.4cm)
127mm f/3.8	1' 5 1/2" (43.3cm)	0.36	6 3/8" × 7 3/8" (15.5 × 18.9cm)
180mm f/4.5	2' 9 1/2" (84.7cm)	0.26	8 3/8" × 10 1/2" (21.9 × 26.7cm)
250mm f/4.5	5' 3 3/8" (160cm)	0.18	1' × 1' 2 5/8" (30.4 × 37.2cm)
360mm f/6.3	11' 4 3/8" (346cm)	0.13	1' 5 1/2" × 1' 9 1/2" (43.8 × 53.4cm)

The lens-to.-subject distance represents the distance of the subject from the front edge of the lens barrel.

* When using the 50mm and 65mm lenses closer than 3 1/4 ft (1 meter), it is necessary to use a lens aperture of f/16 or smaller to obtain satisfactory lens performance.

* Graduations on the upper side of the distance scale represents the bellows extension values (mm).

This scale is used to obtain exposure compensation values for close-up photography with extension tubes. (Refer to the next page.)

◆ Close-up Photography with the Auto Extension Tubes



● Attaching and detaching the auto extension tubes

Attaching and detaching the auto extension tubes is accomplished in the same manner as with the lens. When initially mounting a lens to the extension tube, cock both the lens and the tube.

* The auto extension tubes couple with the automatic diaphragm of the lenses.

NOTES

1. For exposure compensation, refer to the following table. Reading of the exposure compensation scale differs from that when not utilizing extension tubes.
2. For close-up photography, we recommend independent mirror-releasing prior to each actual photograph. This omits or minimizes any residual camera body movement due to mirror action.

3. When photographing through the extension tubes, use as small an aperture as possible.

4. When photographing in the 6 x 7 size, if the 127mm lens is used, minimal or no corner vignetting will occur, however, when using lenses other than the 127mm lens with two extension tubes (No. 1 and No. 2), the possibility of some vignetting in the four corners of the picture may occur. When using only one extension tube, no vignetting will occur with any lens.

5. When photographing with the Polaroid Land film pack, corner vignetting increases due to the larger picture size, however a 6 x 7cm portion in the center of the photo will be essentially clear of vignetting.

6. Use only one auto extension tube No. 1 for the 65mm lens.

7. Since it will decrease resolving power due to exceeding life-size, do not use the auto extension tube with the 50mm lens.

Close-up photography table



1. Distance indicates the distance from the front edge of the lens barrel to the subject.
2. The figures in the left column of the close-up table indicate no bellows extension. The figures on the right indicate when the bellows is extended to the maximum (46mm).

● How to determine the exposure compensation value

1. After focusing the lens, read the extension amount through the bellows extension scale (A) on the top of the distance scale.

2. Find the compensation value by the "Bellows extension scale/Exposure compensation value" located on the right side of the close-up photography table. For example, assume that 127mm lens is focused after combining it with No. 2 auto extension tube. If the extension amount reads 35mm by the bellows extension amount scale, it is understood that the compensation value is +2 steps by the scale located on the right side of the close-up photography table. In this case, increase exposure by setting the shutter speed dial two steps slower or by opening the aperture by two steps.

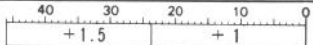
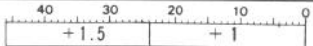
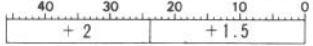
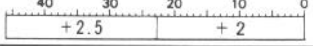
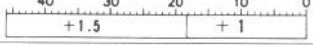
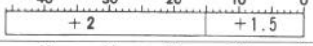
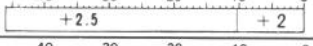
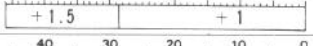
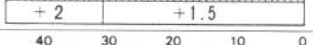
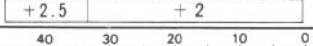
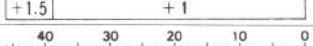
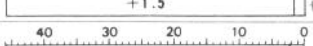
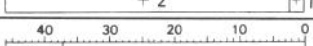
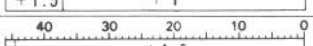
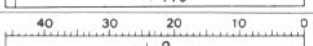
* When using the CdS finder for the Mamiya RB, exposure need not be compensated, since the meter reads actual exposure directly.

Lens	Extension Tube	Magnification	Distance	Subject Size	Bellows extension scale (mm) Exposure compensation value (STEP)
65mm f/4.5	No. 1	0.69~1.40	$3\frac{3}{16}'' \sim 1\frac{1}{16}''$ (8.7~4.0)cm	$3\frac{3}{16}'' \times 3\frac{3}{32}'' \sim 1\frac{1}{16}'' \times 1\frac{1}{16}''$ (8.1×9.9)cm~(4.0×4.9)cm	
90mm f/3.8	No. 1	0.50~1.01	$8\frac{5}{32}'' \sim 4\frac{7}{16}''$ (20.4~11.3)cm	$4\frac{1}{32}'' \times 5\frac{1}{32}'' \sim 2\frac{5}{32}'' \times 2\frac{1}{16}''$ (11.2×13.7)cm~(5.5×6.8)cm	
	No. 2	0.91~1.42	$4\frac{7}{32}'' \sim 3\frac{1}{16}''$ (12.3~8.7)cm	$2\frac{3}{32}'' \times 2\frac{3}{16}'' \sim 1\frac{1}{32}'' \times 1\frac{7}{8}''$ (6.1×7.5)cm~(3.9×4.8)cm	
	No. 1 + No. 2	1.41~1.92	$3\frac{1}{32}'' \sim 2\frac{25}{32}''$ (8.8~7.1)cm	$1\frac{1}{16}'' \times 1\frac{7}{8}'' \sim 1\frac{5}{32}'' \times 1\frac{1}{32}''$ (4.0×4.8)cm~(2.9×3.6)cm	
127mm f/3.8	No. 1	0.35~0.72	$1' 5\frac{3}{8}'' \sim 10\frac{3}{16}''$ (44.1~25.9)cm	$6\frac{7}{32}'' \times 7\frac{7}{32}'' \sim 3\frac{1}{16}'' \times 3\frac{3}{4}''$ (15.8×19.3)cm~(7.8×9.5)cm	
	No. 2	0.65~1.01	$10\frac{1}{32}'' \sim 8\frac{3}{16}''$ (27.9~20.8)cm	$3\frac{1}{16}'' \times 4\frac{3}{16}'' \sim 2\frac{7}{32}'' \times 2\frac{1}{16}''$ (8.7×10.6)cm~(5.6×6.8)cm	
	No. 1 + No. 2	1.00~1.36	$8\frac{7}{32}'' \sim 6\frac{7}{8}''$ (20.9~17.5)cm	$2\frac{7}{32}'' \times 2\frac{1}{16}'' \sim 1\frac{5}{8}'' \times 1\frac{3}{32}''$ (5.6×6.8)cm~(4.1×5.0)cm	
180mm f/4.5	No. 1	0.25~0.51	$2' 9\frac{1}{32}'' \sim 1' 7\frac{1}{32}''$ (86.3~49.9)cm	$8\frac{3}{16}'' \times 10\frac{25}{32}'' \sim 4\frac{3}{8}'' \times 5\frac{5}{16}''$ (22.4×27.4)cm~(11.1×13.5)cm	
	No. 2	0.46~0.71	$1' 9\frac{3}{16}'' \sim 1' 3\frac{9}{32}''$ (53.8~39.6)cm	$4\frac{7}{32}'' \times 5\frac{25}{32}'' \sim 3\frac{1}{8}'' \times 3\frac{3}{32}''$ (12.3×15.0)cm~(7.9×9.6)cm	
	No. 1 + No. 2	0.71~0.96	$1' 3\frac{25}{32}'' \sim 1' 1''$ (39.8~33.0)cm	$3\frac{1}{16}'' \times 3\frac{1}{16}'' \sim 2\frac{29}{32}'' \times 2\frac{29}{32}''$ (7.9×9.7)cm~(5.8×7.1)cm	
250mm f/4.5	No. 1	0.18~0.36	$5' 4\frac{1}{4}'' \sim 3' 5\frac{7}{8}''$ (163~93)cm	$1' 1/4'' \times 1' 2\frac{29}{32}'' \sim 6\frac{1}{16}'' \times 7\frac{7}{32}''$ (31.1×38.0)cm~(15.4×18.8)cm	
	No. 2	0.33~0.51	$3' 3\frac{3}{32}'' \sim 2' 4\frac{1}{16}''$ (100~73)cm	$6\frac{23}{32}'' \times 8\frac{7}{32}'' \sim 4\frac{9}{32}'' \times 5\frac{25}{32}''$ (17.1×20.9)cm~(10.9×13.4)cm	
	No. 1 + No. 2	0.51~0.69	$2' 4\frac{1}{16}'' \sim 1' 11\frac{1}{16}''$ (74~61)cm	$4\frac{1}{32}'' \times 5\frac{3}{16}'' \sim 3\frac{1}{16}'' \times 3\frac{3}{32}''$ (11.0×13.5)cm~(8.1×9.9)cm	
360mm f/6.3	No. 1	0.13~0.25	$11' 6\frac{1}{32}'' \sim 6' 9\frac{1}{32}''$ (352~207)cm	$1' 5\frac{5}{8}'' \times 1' 9\frac{1}{32}'' \sim 8\frac{1}{16}'' \times 10\frac{5}{8}''$ (44.8×54.7)cm~(22.1×27.0)cm	
	No. 2	0.23~0.36	$7' 3\frac{5}{32}'' \sim 5' 5\frac{1}{8}''$ (222~165)cm	$9\frac{1}{16}'' \times 11\frac{1}{16}'' \sim 6\frac{3}{16}'' \times 7\frac{7}{16}''$ (24.6×30.0)cm~(15.7×19.2)cm	
	No. 1 + No. 2	0.35~0.48	$5' 5\frac{7}{16}'' \sim 4' 6\frac{25}{32}''$ (166~139)cm	$6\frac{1}{4}'' \times 7\frac{5}{8}'' \sim 4\frac{1}{32}'' \times 5\frac{5}{8}''$ (15.9×19.4)cm~(11.7×14.3)cm	

◆ Flash Photography

● Connecting the cord



Connect the cord of the flash unit to the sync/flash terminal (46).

● M-X selection

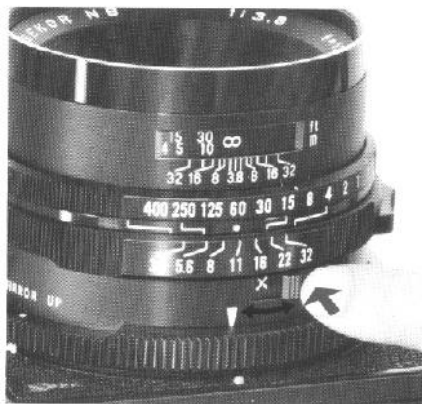

The M-X selecting lever is internally locked to prevent unintentional switching of the mode.

When switching the M-X selector, move the lever to the right or left, until it reaches the end while pressing the lever against the lens barrel.

The letter X or M, which indicates the contact type, should appear in the window.

● Determining the aperture

The aperture setting for flash photography is determined by dividing the guide number of the bulb or the electronic flash unit by the distance.

Example

$$\frac{\text{(Guide number) } 56}{\text{(Distance to subject) } 7} = \text{(Aperture setting) } 8$$

Flash Synchronization Table

Terminal	Flash bulb	Shutter speed									
		1	1/2	1/4	1/8	1/15	1/30	1/60	1/125	1/250	1/400
M	M-class										
X	Electronic flash										
	F-class								×	×	×
	M-class							×	×	×	×

* When employing electronic flash, set the M-X selector to X to synchronize flash at any shutter speed.

* When M-class flash bulbs are used, set the M-X selector to M to synchronize at any shutter speed.

* When F-class flash bulbs are used, set the selector to X and photograph at 1/60 sec. or a slower shutter speed.

◆ Mirror-up Photography (Independent Mirror Release)

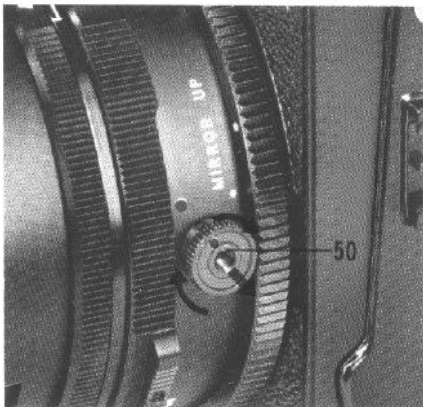

In mirror-up photography, previously release the mirror and operate only the lens shutter at the moment of taking the photograph. This mirror-up photography is recommended When a tripod is employed and the shutter is released at slow speed, when taking close-up photos, or when using a telephoto lens, where avoidance of even a negligible shock is desired, or when curtailment of even a negligible time lag between pressing the shutter release button and the shutter opening is desired

• Preparations

1. Pull out the independent mirror release operating knob (50) and turn it clockwise, and align the red dot on the knob with the MIRROR UP indication dot.
2. Screw a cable release into the female

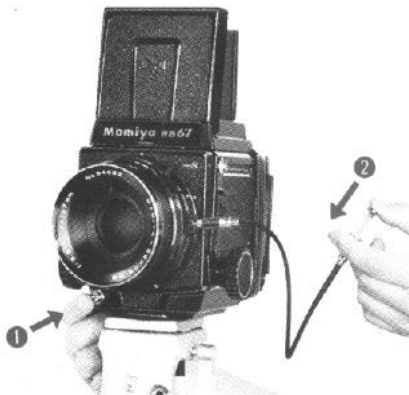

3. By fully pressing down the shutter cocking lever, cock the shutter and the mirror.
- ¶ The sequence of foregoing procedures 1, 2, and 3 can be optionally altered.

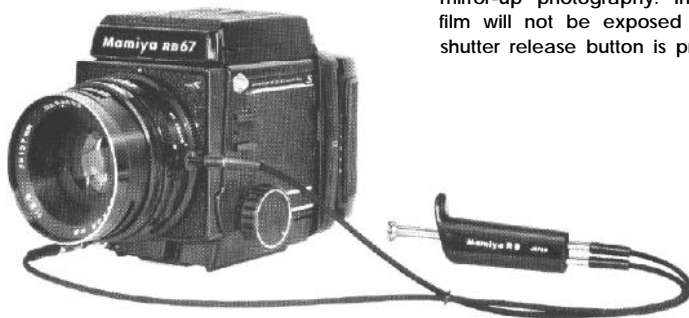

• Photographing

1. On pressing the shutter release button, the mirror and the light baffle will snap up, but the shutter will not be released.
2. Release the shutter with the cable release. (When you do not have a cable release, simply return the mirror release Operating knob to the original position to release the shutter.)
3. By pulling out the knob and turning it counterclockwise, the mirror-up mechanism can be disengaged.

¶ Even when picture-taking is switched to mirror-up photography, the mirror is set at each shutter cocking. Accordingly, it is possible to confirm the image on the finder screen prior to taking each picture.

¶ For this type of photography, an ideal forked mirror-up cable release is available as an optional accessory.

NOTE:

Unless the mirror release operating knob is returned, the camera will remain set for mirror-up photography. In this case, the film will not be exposed even when the shutter release button is pressed.

◆ Lens Hood

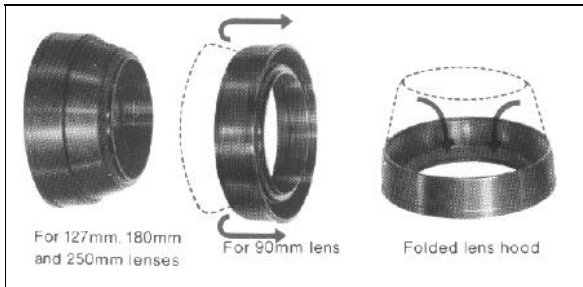

This lens hood can be used commonly for the 90mm, 127mm, 180mm, and 250mm lenses.

1. Screw the attachment ring into the front of the lens mount.
2. Pull the folded rubber hood straight out, using it as the hood for the 127mm, 180mm, and 250mm lenses.
3. For the 90mm lens, fold the hood back halfway

To fold the hood, pull it straight out, place the hood on a flat surface, and push down from the top to easily fold the lens hood

You can also leave the hood on the lens for portability by pushing back and turning out the hood while it is attached to the lens.

A filter can be screwed in between the lens and the hood, or in front of the lens hood.

◆ Carrying Strap

●Attaching

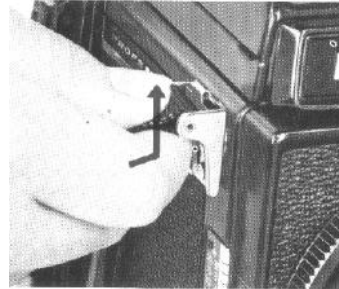

While holding both sides of the strap attaching metal, slide the attaching metal toward the hanging direction, after fitting and pressing the round hole on the metal back side to the lug for strap on the camera body.

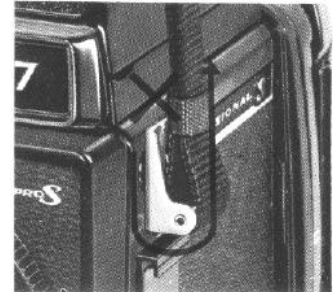

Note:

Always attach and use the strap so that it and the strap attaching metal are straight.

When changing the strap hanging direction, always reattach the strap.

* If the strap attaching metal is connected to the accessory shoe side in reverse, detaching will be difficult.

- Detaching

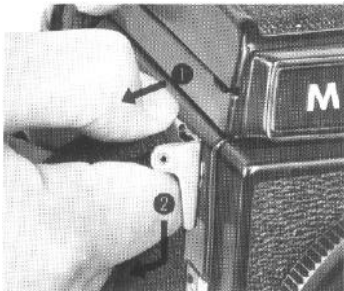

To detach the strap, slide the attaching metal in reverse direction to attaching, while slightly raising the leaf spring on the attaching metal with a finger tip.

- Holding the camera by the strap



After adjusting the length of the carrying strap, pass your left hand through the strap, and while stretching the strap down from your neck, hold the camera with your left hand. The camera can be held lightly, easily, and securely in this manner.



- Three hanging positions

Depending on the attached position of the strap, there are three hanging positions for the strap as illustrated in the photos. Since the strap attaching lug is not rotary, the strap will never become twisted.

◆ Magnifier

● Changing the magnifier

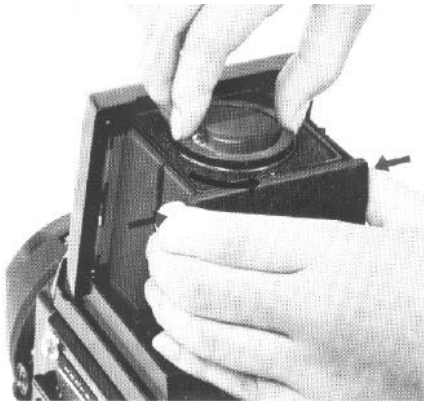

While holding both side panels of the focusing hood to prevent lowering of the magnifier base plate, turn the magnifier counter-clockwise, and at the point where the white dot on the magnifier becomes aligned with the white dot on the base plate, remove the magnifier.

After aligning the magnifier white dot with the base plate white dot, mount another magnifier by turning it clockwise.

* In addition to the standard (-1.3) diopter lens, available are +1, 0, -1, -2, and -3 diopter lenses (six in total).

◆ Focusing Hood

● Detaching



While pressing the focusing hood latch (9), slide the nameplate (8) to the right as viewed from the front, and remove the focusing hood while slightly raising its front portion.

● Attaching

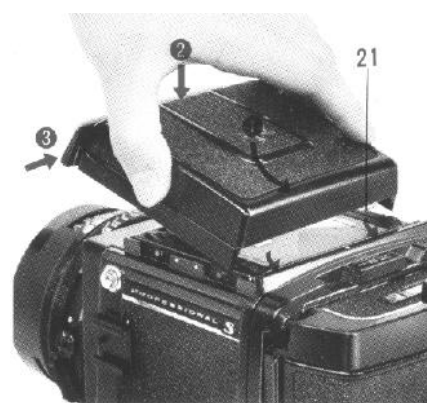

Insert the two prongs (21) on the back of the hood into the slots on the camera body, and while pressing the hood front portion toward the camera body, return the nameplate to its original position. The latch will pop out and the hood will be locked automatically.

◆ Focusing Screen



Five types of easily exchangeable focusing screens are available to meet various photographing applications.

■ Attaching and detaching

First remove the focusing hood, then take out the focusing screen while holding both sides.

To attach it, hold each side and insert the focusing screen into the top of the camera body and press down lightly.

NOTE:

When the focusing screen has been detached, do not touch the picture format indicating red dot on the side of the camera body.

□ Revolving Adapter

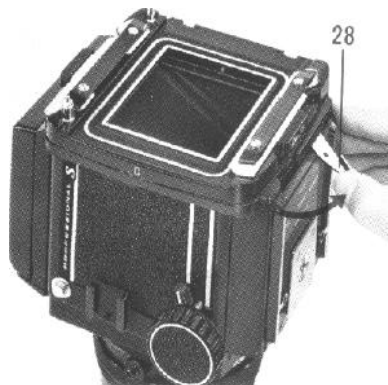

To detach the revolving adapter, pull out and down on the R-lock lever (28) at the bottom of the camera body.

To attach the revolving adapter to the camera body, face the white index dot on the adapter toward the top of the camera body, and fully push the R-lock lever up, while firmly pressing the adapter toward the camera body.

⚠ When attaching the revolving adapter, press it firmly so that it is attached tightly and never comes loose. If the adapter is attached somewhat loosely, it will cause light leakage.

⚠ The revolving adapter of the Pro-S is not applicable to the former RB67.

⚠ Since the revolving adapter for the former RB67 has no interlocking mechanisms (such as a double-exposure preventive device, a horizontal picture format marking device, and a safety device for preventing the shutter from releasing when the dark slide is inserted), do not employ it with the Pro-S body.

When desiring to pull out the dark slide of the roll film holder which has been removed from the body

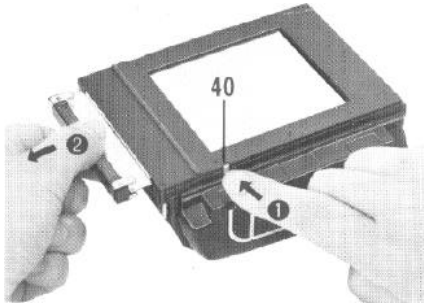

When the roll film holder for the Pro-S is removed from the body, the safety device prevents its dark slide from being pulled out carelessly or accidentally. However, if you desire to pull it out, it can be pulled out by using your fingernail tip to press the dark slide lock release lever (40) on the bottom of the outer cassette.

Releasing the lens shutter which has been removed from the body



It is advisable to release the shutter when the lens is not to be used for a long period. To release a lens shutter which is removed from the camera body, turn the cocking pins (56) clockwise, while pressing the shutter lock pin (55) with a finger. The cocking pins should be turned all the way; do NOT leave the pins turned only halfway..

Shutter testing when the film is loaded



When the shutter is cocked, the dark slide is slightly pulled out (approx. 1/4 in.) and the shutter release button is pressed, the shutter can be released without exposing the film in the roll film holder to light. This operation can be utilized for shutter testing prior to photographing.

* When pulling out the dark slide, stop pulling at a point where the entire triangular hole on the dark slide becomes visible. If the shutter is released when the dark slide is pulled out beyond that hole, the film will be exposed to light.





* When the shutter is released, a red mark appears on the exposure counter.

* When taking the first photograph subsequent to this test, cock the shutter in the multiexposure condition, and pull out the dark slide. For taking pictures following the first one, restore the multiexposure lever to its normal position and continue photographing.

When the lens is installed on the camera while the mirror and the shutter are not set.

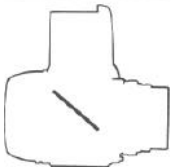
Lens installation is possible even if the mirror and/or the shutter are/is not set; however, operation shown in the table must be followed to obtain a normal set condition. In this case, do not pull out the dark slide of the film holder until the camera is set to a normal condition.

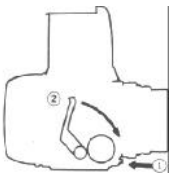
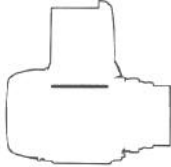
However, when the shutter release button is necessarily pressed with the roll film holder attached, as shown in "1" of the table, move the multiexposure lever forward and slightly pull out the dark slide, and then press the shutter release button.

	Mirror condition	Shutter blade condition	Operation
1		 Closed	
2		 Opened or Closed	

◆ Lock System of the Camera Back (Attaching System)

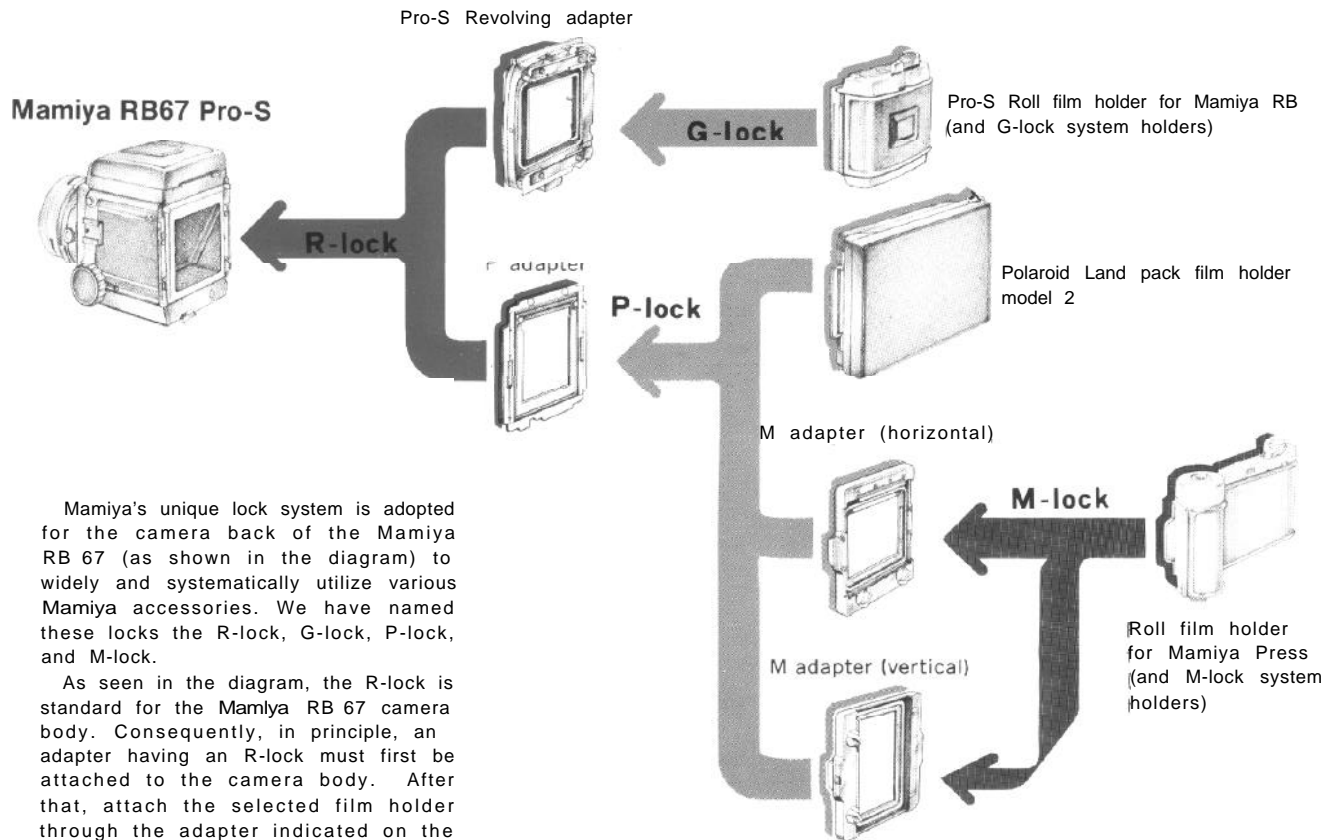

Mamiya's unique lock system is adopted for the camera back of the Mamiya RB 67 (as shown in the diagram) to widely and systematically utilize various Mamiya accessories. We have named these locks the R-lock, G-lock, P-lock, and M-lock.

As seen in the diagram, the R-lock is standard for the Mamiya RB 67 camera body. Consequently, in principle, an adapter having an R-lock must first be attached to the camera body. After that, attach the selected film holder through the adapter indicated on the diagram.

When the roll film holder for the former RB67 is used on the Pro-S camera body.

Since the former roll film holder is not equipped with a coupling device for double-exposure prevention, operate it in the same manner as if it were mounted on the former RB67 camera body.

When the roll film holder for the Pro-S camera body is used for the former RB67 camera body.

Although the coupling device for double-exposure prevention does not function in this case, the film wind-stop device is automatically released when the shutter is released, and the film is ready for winding.

Other operating methods are the same as those when using the former RB67 camera body.

When the roll film holder for the Pro-S is used for the Mamiya Universal Press.

Use in the same manner as when the roll film holder for the former RB67 is mounted on the Mamiya Universal Press.

When the film wind-stop release lever (42) is moved to the left, a red mark appears on the exposure counter, the wind-stop is released, and the film is ready for winding.

When film holders for the Mamiya Press are used for the Pro-S camera body.

When using these holders, mount each holder on the camera body back through a P-adapter and an M-adapter.

These holders can be handled in the same manner as if they were mounted on the Mamiya Press.

When photographing in a horizontal format, the horizontal format marking lines (red lines) do not appear on the finder. Accordingly, refer to the red lines which appear when the revolving adapter is attached, and mark the format with a piece of tape on the ground glass focusing screen.

When Polaroid Land pack film is used with the Pro-S camera body.

When using the Polaroid Land pack film holder, use a P-adapter to mount it on the camera body back.

Compose the picture through full view of the ground glass focusing screen. In this case, the actual picture size will become approximately 2 3/4 x 2 3/4 in. (7 x 7cm).

◆ Mamiya RB67 Operation Diagram

1 Shutter setting condition

Shutter blade



Aperture blade

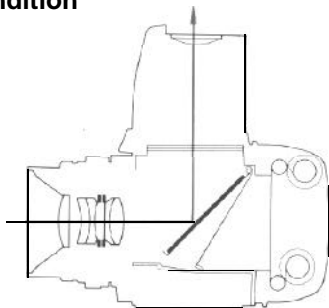

- Both the shutter blade and the aperture blade are opened.
- The mirror and the light baffle are lowered to the set position.

2 Just after pressing the shutter release button

Shutter blade



Aperture blade

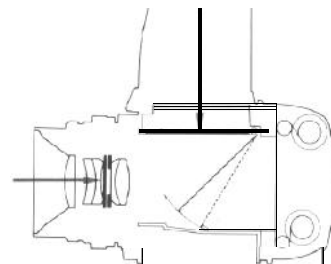

- The shutter blade is closed and the aperture blade begins stopping down.
- The mirror is raised and the light baffle starts rising.

Mirror-up photography (Refer to page 29)

Shutter blade

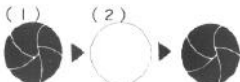

Aperture blade

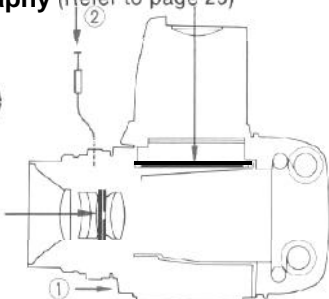

- (1) When pressing the shutter release button:
 - The shutter blade is closed and the aperture blade stops down to a preselected aperture.
 - The mirror and the light baffle are raised.
- (2) When releasing the shutter, using the mirror-up release:
 - Only the shutter blade operates, closing after being fully opened.

3 Exposure

Shutter blade



Aperture blade

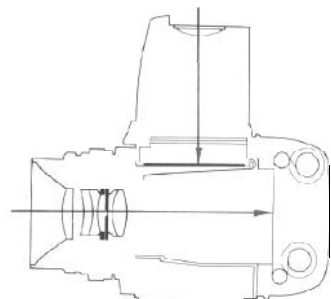

- The light baffle is raised to its limit.
- The aperture blade stops down to a preselected value
- The shutter blade is closed after being fully opened.

◆ Special Pointers on Using the Mamiya RB67 Pro-S

Various safety interlock devices are provided for the Mamiya RB67 Pro-S to eliminate failures through carelessness. When the shutter is not released, or when the lens or the roll film holder cannot be removed, do not hastily conclude that this indicates a camera malfunction. Ascertain the following conditions. The Instruction Manual pages covering these situations are indicated in parentheses.

- **Shutter release button cannot be depressed**

(1) Is the roll film holder loaded with a roll of film and has the film been advanced to the first exposure?

When shutter releasing is desired without loading film, by sliding the multiexposure lever forward and setting the shutter cocking lever and pulling out the dark slide, the shutter can be released. (P.17)

(2) After the shutter was released during ordinary exposure (not under multiple exposure), did you advance the film?

Advance the film with the film advance lever.

(3) Is the mirror set?

Set the mirror by pressing down the shutter cocking lever.

(4) Was the dark slide drawn out?

Draw out the dark slide.

(5) Is the shutter release button locked?

Turn the shutter release lock ring counterclockwise and align it with the white dot. (P.13)

(6) Is the revolving adapter turned up to the click stop position?

Turn the adapter until it stops with a click. (P.15)

(7) Has the slide lock on the revolving adapter stopped halfway?

Move the slide lock up to the position where it stops. (P.16)

- **Lens cannot be removed**

Press down the shutter cocking lever. Set the mirror and the shutter. (P.13)

- **When mounting the film holder, the slide lock cannot be moved**

While pressing the slide lock release lever, move the slide lock to the left. (P.16)

- **Roll film holder cannot be removed**

After inserting the dark slide, operate the slide lock.

- **Regarding the mirror release operating knob**

Normally align the knob with the red dot. When it is aligned with the MIRROR-UP index mark, and merely the shutter release button is pressed, the mirror and the light baffle will operate, but no image will be recorded on the film. (P. 29)